

## 70m 4x4 HDMI 2.0 Matrix Extender with 4 hdmi loop out Support 4K60hz YUV4:4:4, 18Gbps, HDR (HLG)

### OPERATION MANUAL



**Thank you for purchasing this product. For optimum performance and safety, please read these instructions carefully before connecting, operating or adjusting this product. Please keep this manual for future reference.**

## **SURGE PROTECTION DEVICE RECOMMENDED**

**This product contains sensitive electrical components that may be damaged by electrical spikes, surges, electric shock, lightning strikes, etc. Use of surge protection systems is highly recommended in order to protect and extend the life of your equipment.**

## Catalogue

1. Features.....	4
2. Package Contents.....	4
3. Specifications.....	4
4. Panel Descriptions.....	5
5. Wiring Diagram.....	6
6. Input / output channel key operation.....	7
7. Video switching operation.....	8
7.1. Video switch.....	8
7.2. Video Control.....	8
The specific operation as follows:.....	8
7.3. Audio Control.....	10
7.4. EDID Set Mode Interface.....	12
7.5. Preset Interface.....	13
7.6. SETUP mode Interface.....	14
7.6.1. RS-232 Baud Rate setting.....	15
7.6.2. DHCP On/Off setting.....	15
7.6.3. POC power switch.....	15
7.6.4. Reboot setting.....	16
7.6.5. Factory setting.....	16
7.7. INFO mode Interface.....	18
8. Audio Extraction.....	19
9. Remote Control Description.....	19
10. IR system.....	20
11. Command Control.....	20
12. Web Control.....	22
12.1. Enter Web and Control.....	23
12.2. “Status” interface:.....	23
12.3. “Input” interface:.....	24
12.4. “Output” interface:.....	24
12.5. “Preset” interface:.....	25
12.6. “Network” interface:.....	25
12.7. “System” interface:.....	25
13. FW UPGRADE.....	26
13.1. MCU Upgrade:.....	26
13.2. CPLD Upgrade:.....	26
13.3. HTML (WEB GUI) Upgrade:.....	27
MAINTENANCE.....	28
PRODUCT SERVICE.....	28
WARRANTY.....	28

## 1. Features

- 4 x HDMI input and 4 x Ethernet output with 4 x HDMI Loop out
- HDMI 2.0 version support 4K@60Hz YUV4:4:4, 8bit, 18G, HDR-HLG
- Extending 4K60Hz video signal to distances up to 70m over single Cat6 Ethernet cable
- HDCP 2.2/1.4 compliant
- With wide-band Bi-Direction IR routed control(38~56KHz)
- Support 4x Analog Audio extraction (3pin phoenix port)
- Support 4x SPDIF Audio extraction output
- Support Panel Button with LCD, IR Remote control, RS232 Control, TCP/IP Control
- Includes smart EDID management
- Support Micro USB for FW updating

## 2. Package Contents

- 1). 1x Main Unit (HDMI Matrix Extender)
- 2). 1x DC12V4A Power adapter
- 3). 1x Remote control
- 4). 9xIR Transmitter cables, 9x Wide-Band IR Receiver cables
- 5). 1x CD for user manual & Command list
- 6). 8x 3Pin plug for Analog audio output port
- 7). 1U rack design metal case with 2 mounting ear

## 3. Specifications

Operating Temperature Range	-5 to +40°C(23 to +104 °F)
Storage Temperature Range	-10 to +60°C(-14 to +140 °F)
Operating Humidity Range	5 to 90 % RH (no condensation)
Input Video Signal	0.5-1.0 volts p-p
Input DDC Signal	5 volts p-p (TTL)
Bandwidth	18Gbit/s
Video Format Supported	4K@60Hz,YUV4:4:4 8bit 4k@30Hz/1080P/1080i/720P/576P/480P/576i/480i
HDCP Compliant	HDCP 2.2 and HDCP 1.4
Output Video	HDMI 2.0 Version
Audio Format Supported	PCM, Dolby5.1, DTS5.1 digital audio
Maximum Transmission Distance	70m
Power Consumption	45 watts (Max.)
Dimensions	Matrix: L438 x W394 x H44 mm Receiver: L110.2xW68.3xH18 mm
Mass (Main Unit)	3 KG

## 4. Panel Descriptions

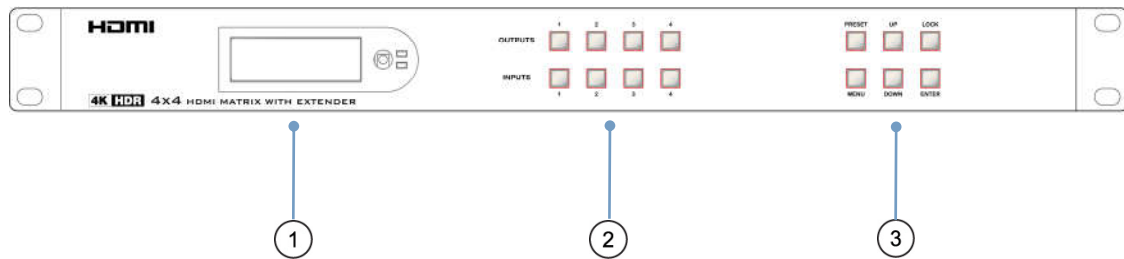

- ① LCD: Showing Matrix information
- ② Output button OUT1~4 & Input button IN1~4
- ③ Function button: PRESET; MENU; UP; DOWN; LOCK; ENTER

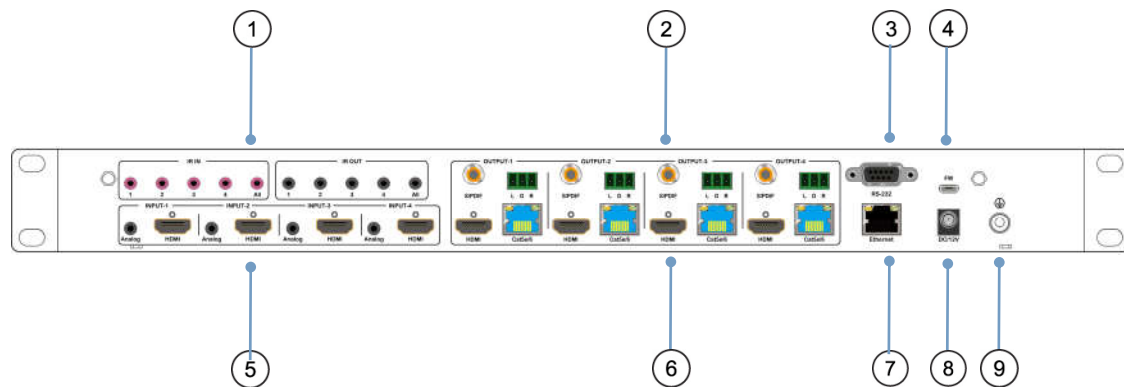

- ① IR input port x4 & All in & IR output port x4 & All out
- ② Audio out (Analog x4; SPDIF x4)
- ③ RS232 port
- ④ FW update port
- ⑤ HDMI input x4
- ⑥ Ethernet output x4 & HDMI Loop out x4
- ⑦ Ethernet port
- ⑧ Power On/Off
- ⑨ Grounding

## 5. Wiring Diagram

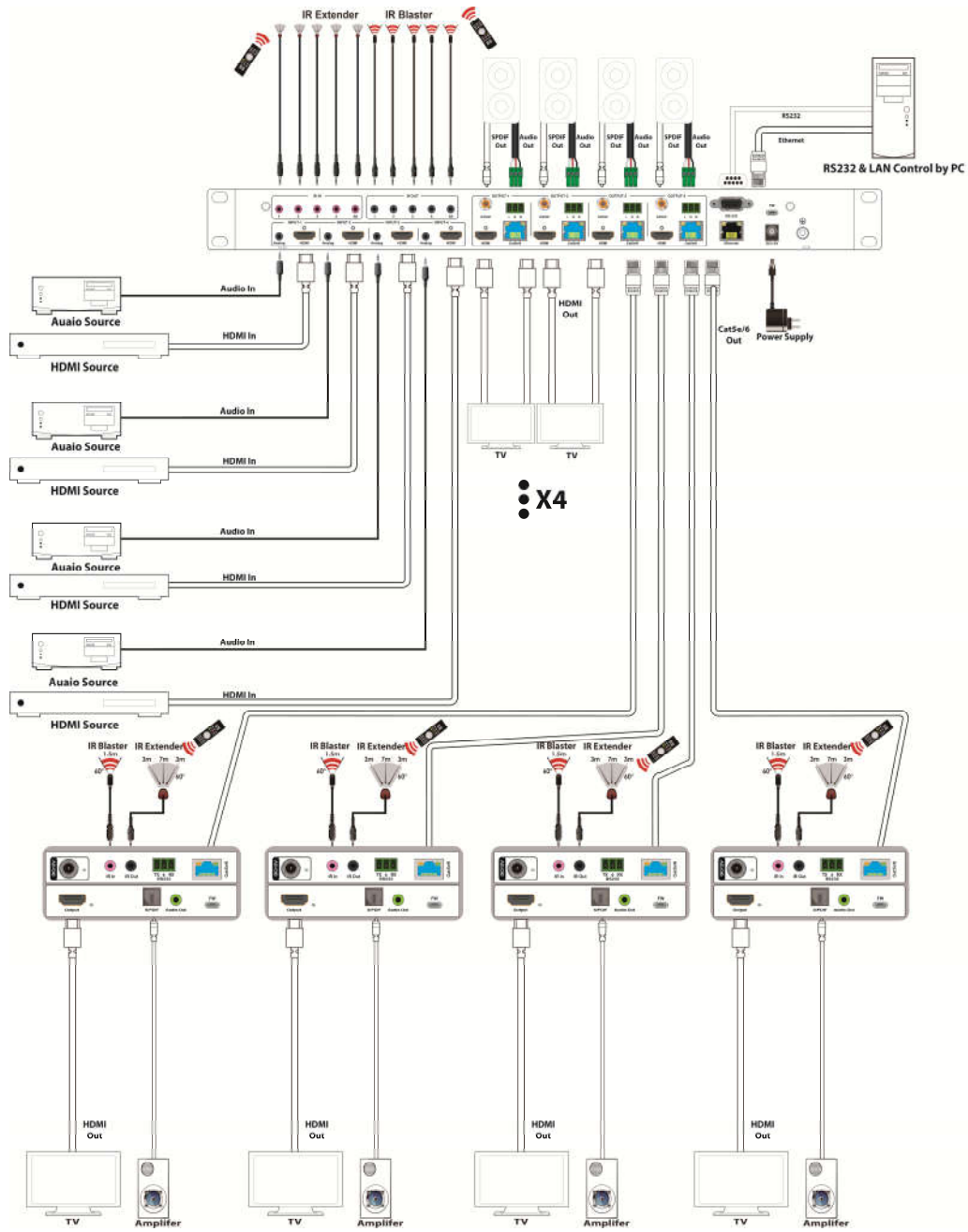



**6. Input / output channel key operation**

Channel	Button method
Input 1-4	1. Directly press the number key, such as input channel 1, and select "1" to press (only when the output port is selected, the input channel number will be valid) 2. Long press means all outputs select current input
Output 1-4	Directly press the number key, such as the output channel 2, press button "2" and press it again to cancel the selection; Long press output 4 to select all channels, and long press again to cancel
MENU	Function Button; Enter the function option or back to previous option
ENTER	Confirm Button: enter function selection mode
UP	Button for UP option
DOWN	Button for NEXT option
PRESET	Preset, short press to quickly enter the preset call function
LOCK	Long press to LOCK, Long press again to UNLOCK

## 7. Video switching operation

### 7.1. Video switch

The signal switch includes 4 free switching channels, which can be configured as input/output according to the requirements, forming a matrix of 1 x 4 ~ 4 x 1, which can switch any input. Signal to 1 channel output or all channel output.

**The specific operation as follows:**

Output	1	2	3	4
Input	1	2	3	4

Switch the input to the output

Operation format: "output channel" + "input channel"

For Example: Output port 2 switch to input 1

Operation: Press OUT number "2" + IN number "1" to complete the switch

### 7.2. Video Control

The video interface have two sub menu

1. Video Switching
2. Video On/Off

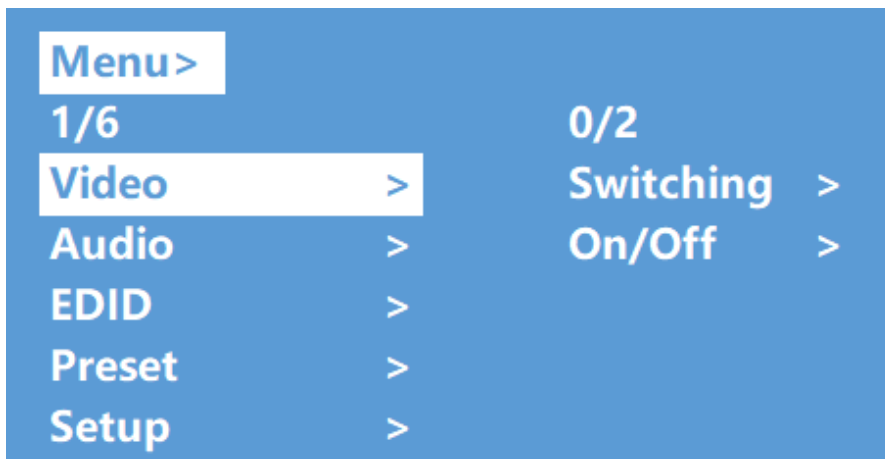

**The specific operation as follows:**

#### 1. Video Switch

Switch any output to one input or all outputs to the same input, default PTP.

①Select "Video" in the menu and press "ENTER"



- ②Then use "UP" " DOWN" button to select "Switching"
- ③Press "ENTER" enter next page
- ④Press "UP" " DOWN" button to select the output (The fifth port means ALL)
- ⑤Press "ENTER"
- ⑥Press "UP" " DOWN" to select the input
- ⑦Press "ENTER" , Switching Done

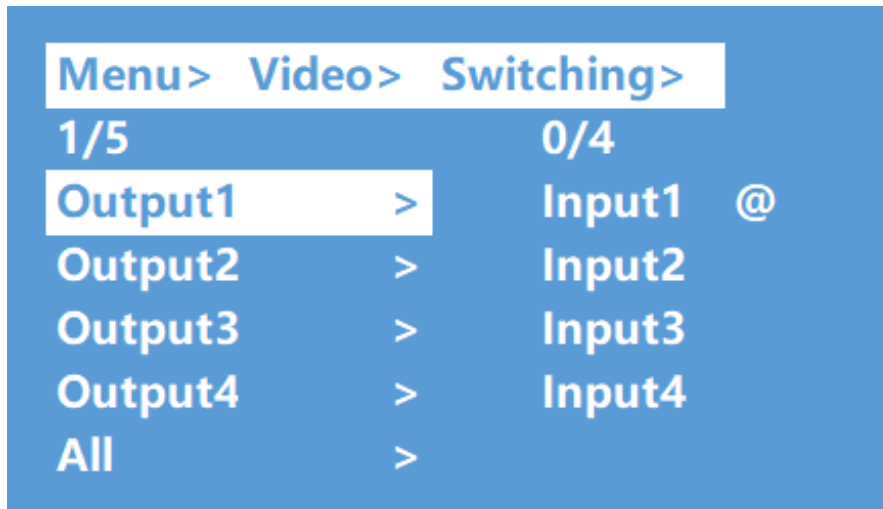
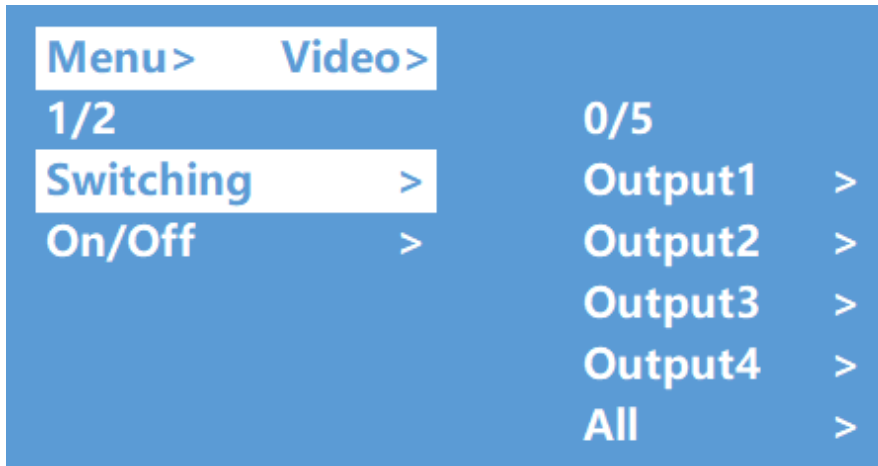

## 2.Video On/Off

Turn on/off any output video or all outputs video

- ①Select "Video" in the menu and press "ENTER"
- ②Then use "UP" " DOWN" button to select "On/Off"
- ③Press "ENTER" enter next page
- ④Press "UP" " DOWN" button to select the output (The 5th port means ALL)
- ⑤Press "ENTER" to select the Output 1~5
- ⑥Press "UP" " DOWN" to select "On" or "Off"
- ⑦Press "ENTER" , Switching Done

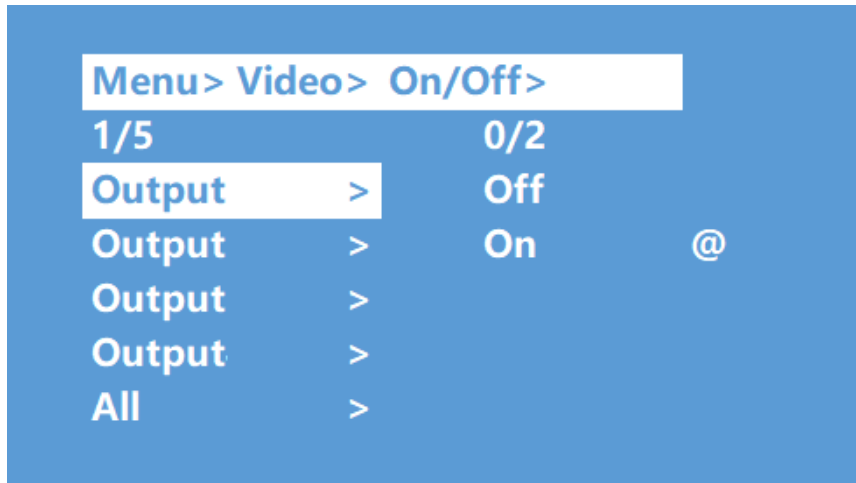

### 7.3. Audio Control

The Audio Control has four sub menu

1. Input Audio (Default On)
2. Embed (Default Off)
3. Analog out (Default On)
4. SPDIF out (Default On)

**The specific operation is as follows:**

1. Input Audio

HDMI input audio switch. You can select any one of HDMI input source audio to be mute

2. Audio Embed

Audio can be embedded to HDMI input. The embedded sound will cover the original sound of the signal source. You can select any one of the input to embed

3. Analog/SPDIF Audio Out

Can choose any one of the Analog/SPDIF audio output on or off

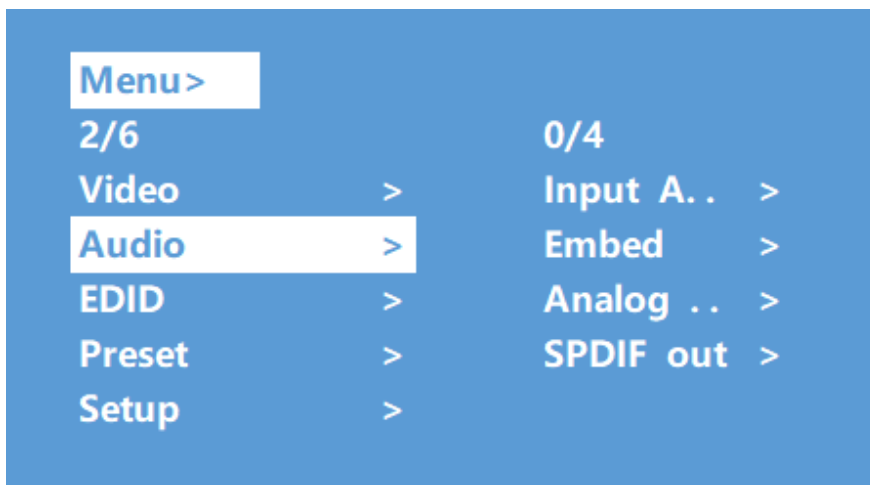

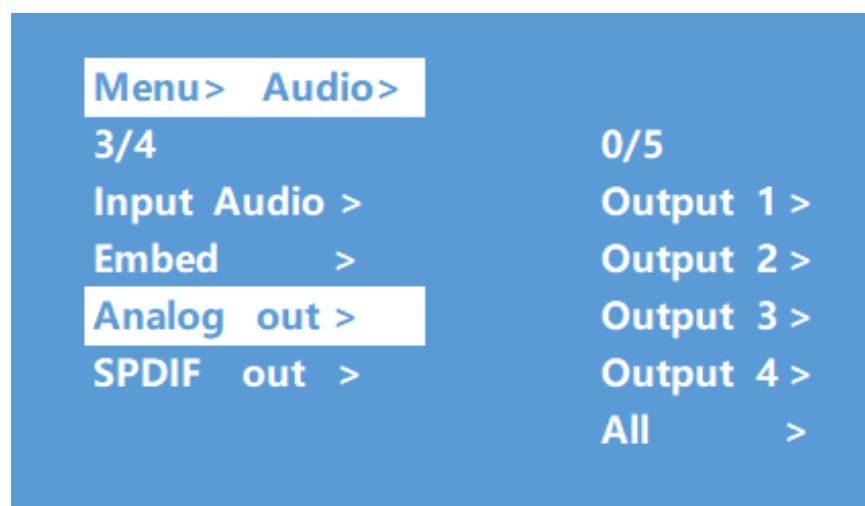
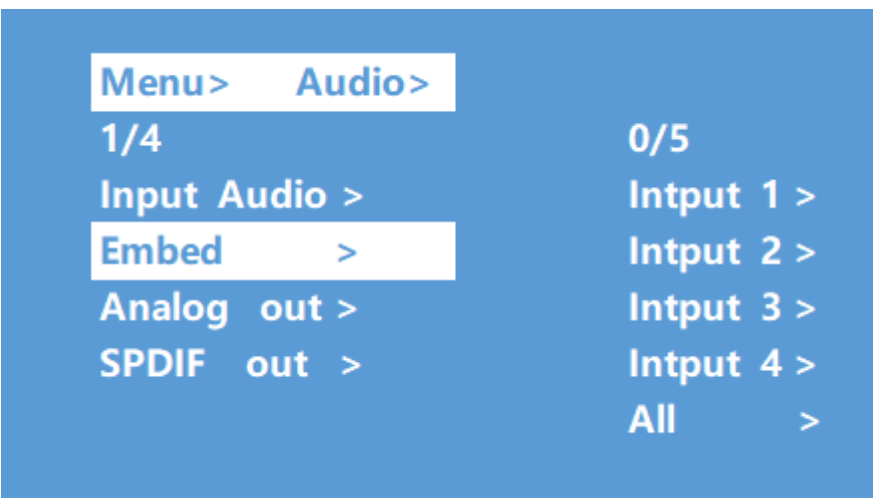

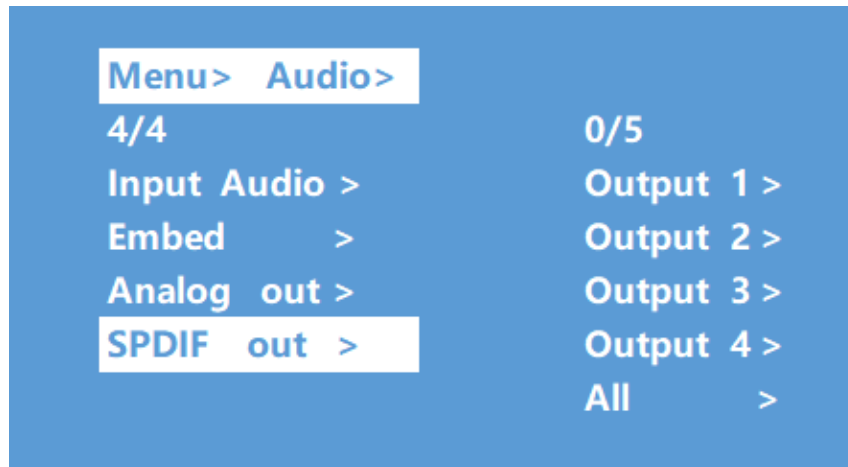

#### 7.4. EDID Set Mode Interface

##### Default EDID

Default-1	1080P60hz-2.0	Default-5	4K60hz-YUV420-5.1
Default-2	1080P60hz-5.1	Default-6	4K60hz-YUV444-2.0-HDR:HLG
Default-3	1080P60hz-7.1	Default-7	4K60hz-YUV444-5.1-HDR:HLG
Default-4	4K60hz-YUV420-2.0	Default-8	4K60hz-YUV444-7.1-HDR:HLG

**EDID Mode can set each input's EDID, Include: Default EDID; User EDID; Copy EDID; Copy UTP Remote side EDID.**

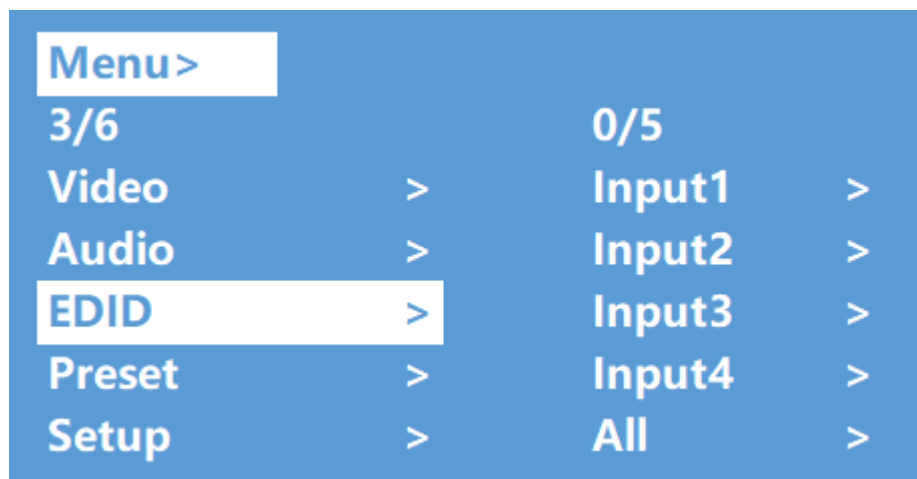

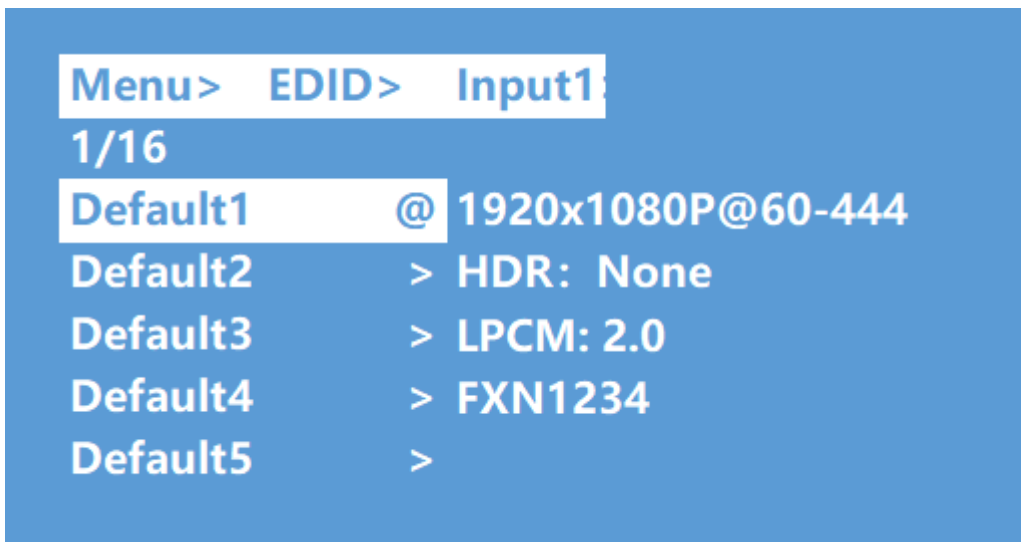
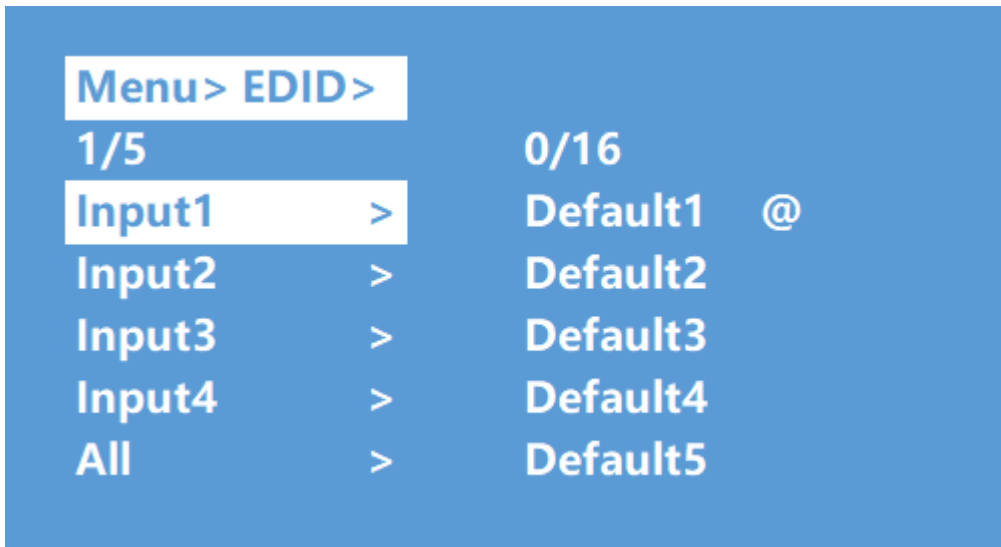

### 7.5. Preset Interface

The PRESET interface can save the current video, audio, EDID, system Settings, etc., and supports 8 different scenes. Scenes can be modified and cleared through web pages, commands, and panels. The default preset is consistent with factory Settings



### 7.6. SETUP mode Interface

SETUP mode can set the device's RS-232 baud rate, POC Switch, DHCP, Reboot, Factory Specific operations are as follows

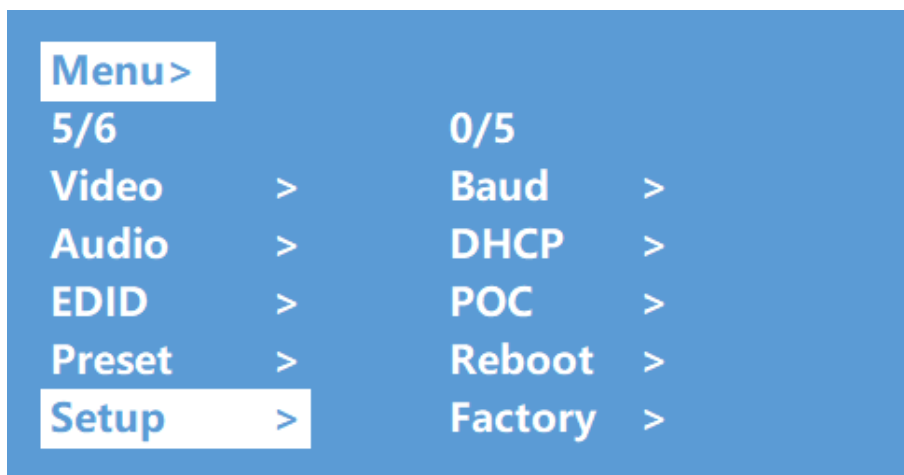

### 7.6.1. RS-232 Baud Rate setting

It has 4 kinds of baud rates inside the device: 38400,19200,57600,115200

Default Baud Rate is: 115200

- ①Select "Setup" in the menu and press "ENTER"
- ②Then use "UP" "DOWN" button to select the "BAUD" and press "ENTER"
- ③Press "UP" "DOWN" button to select the baud rate and press "ENTER" to confirm

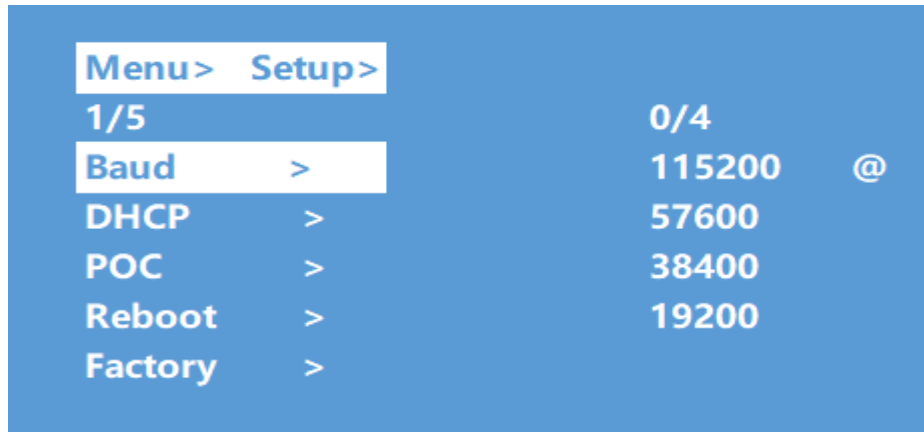

### 7.6.2. DHCP On/Off setting

On means Dynamic; Off means Static

- ①Select "Setup" in the menu and press "ENTER"
- ②Then use "UP" "DOWN" button to select the "DHCP" and press "ENTER"
- ③Press "UP" "DOWN" button to select "On" or "Off" and press "ENTER" to confirm

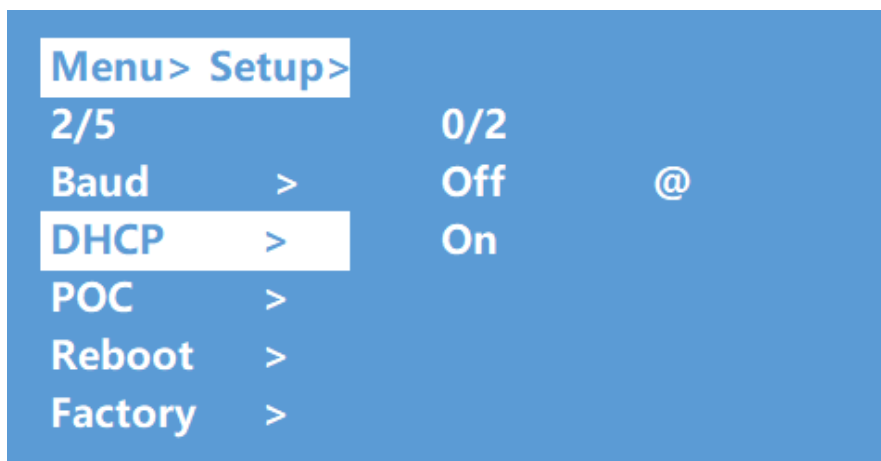

### 7.6.3. POC power switch

The POC interface can select a certain UTP (Remote side) output switch to control POC power supply, and the default POC is "On"



#### 7.6.4. Reboot setting

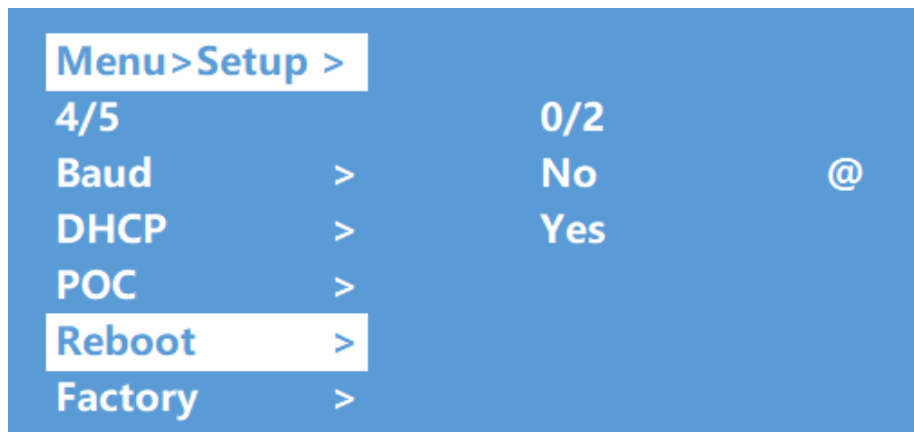

#### 7.6.5. Factory setting

Factory Run: Reset Video, Audio, EDID, Setup setting,

Factory User: Reset Video, Audio, EDID, Setup setting, Preset, Device name.



**Menu> Setup>**

5/5

0/2

Baud >

User >

DHCP >

Run >

POC >

Reboot >

**Factory >**

**Menu> Setup> Factory >User>**

1/2

**No** @

Yes

Reset information:

1.Video 2.Audio

3.EDID 4.Setup

5.Preset 6.Name

**Menu> Setup> Factory >Run>**

1/2

**No** @

Yes

Reset information:

1.Video 2.Audio

3.EDID 4.Setup

### 7.7. INFO mode Interface

Check the device information: IP or System information

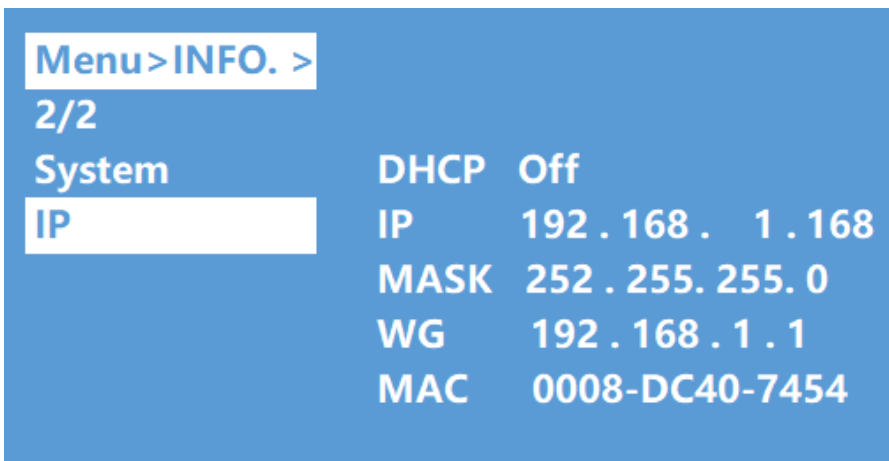
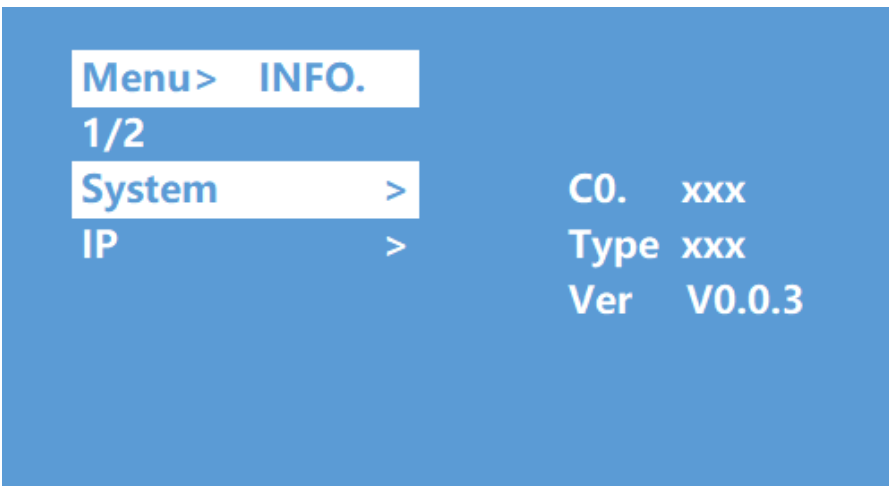
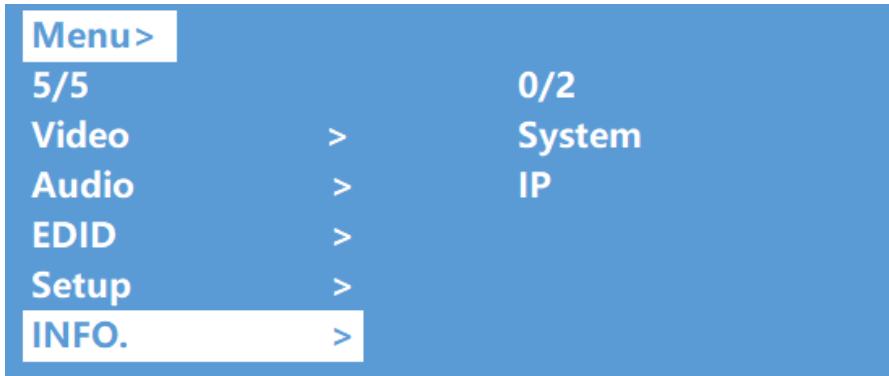

## 8. Audio Extraction

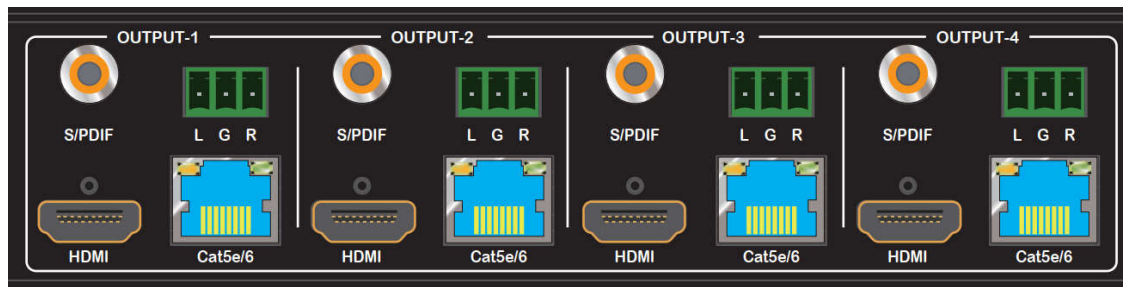

HDMI audio output supports uncompressed audio PCM, compressed audio Dolby and DTS, with a maximum support of 7.1 sound channels and a maximum sampling rate of 192KHz.

Analog audio supports PCM 2.0 channel.

S/PDIF audio supports Dolby or DTS, 5.1 channel.

## 9. Remote Control Description

- ① Standby Mode
- ② Lock or Unlock the Panel Button
- ③ Choose output from 1-4
- ④ Choose all the outputs.
- ⑤ X: Turn on/off output port which you select
- ⑥ PTP button: Mirror all inputs and outputs  
(Ex. Input 1 to output 1, input 2 to output 2, etc)
- ⑦ Choose input from 1-4
- ⑧ Menu (back to previous option) button
- ⑨ UP and DOWN button
- ⑩ Enter button

**Note:** When Press “Output” Button + “M” Button can turn on/off the Output’s Audio

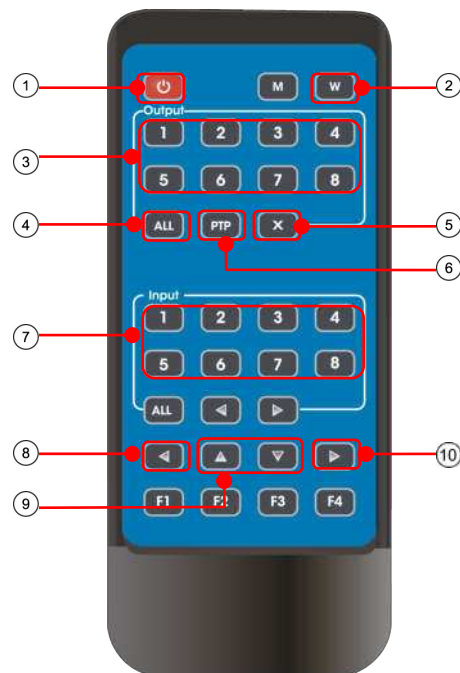

## 10. IR system

The matrix can pass the IR signal through the IR system to the HDMI source or pass the IR signal from the HDMI source to the HDMI sink

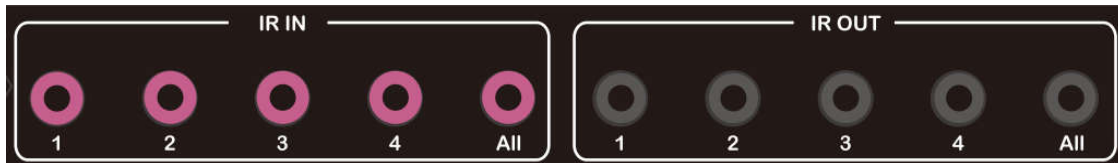

### Dual way IR using:

Step1: "IR IN" is for UTP output, "IR OUT" is for input channel

Step2: "IR IN ALL" Controlled by all input IR; "IR OUT ALL" Controlled by all output IR.

Step3: Receiver support connect with IR receiver to control the Matrix by remote

Step4: Matrix IR channel "IR IN ALL" support connect with IR-RX cable to control the Matrix by remote

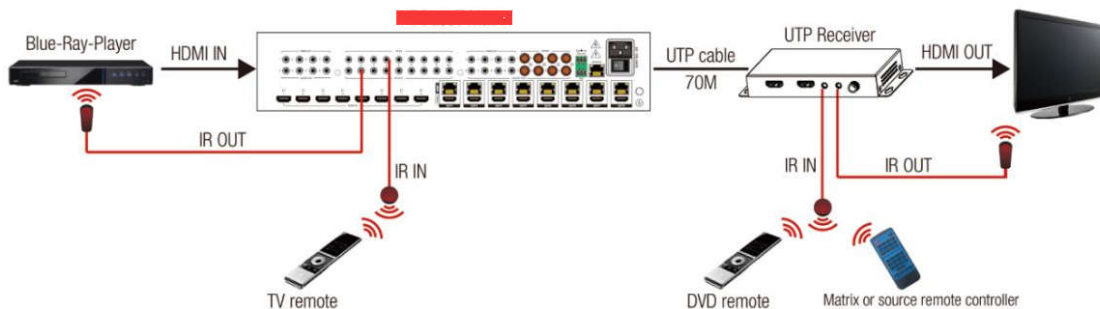

## 11. Command Control

Control software operation:

The serial control software is illustrated with SSCOM32 as an example.

Basic Settings:



Double-click the software in the installation package to run specifically (as shown in figure 1 below) and install the RS232 software on the computer.

**Enter the main interface of the software, as shown in the figure below.**

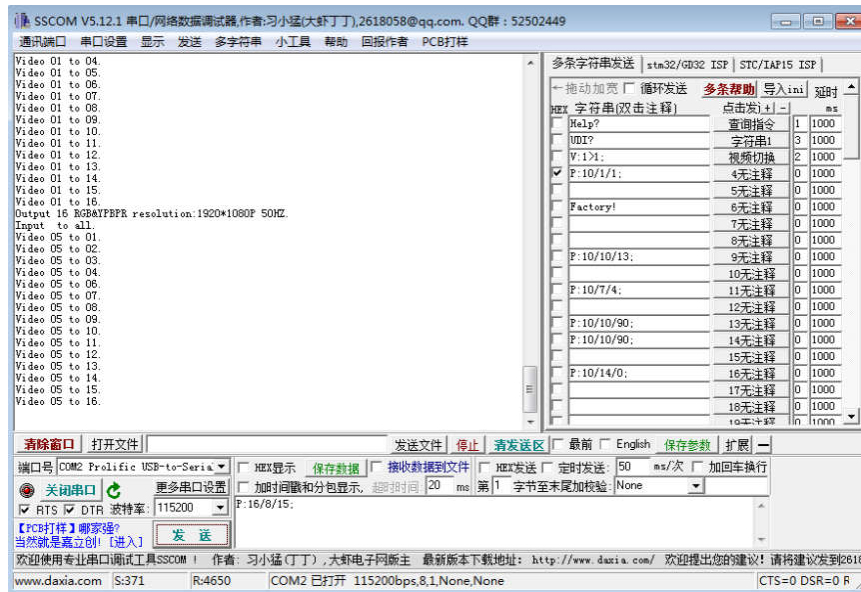

In the parameter configuration area, select the serial port number that the serial line connects to the PC

Baud rate: 115200 (default)

Data location: 8.

Stop bit: 1

Check bit: no

Then can input commands in the command input area to control the local or remote receiver

**Instructions:**

1. All commands start from “#”, command head “%c”: “d” parameters, “l” lock, “s” save.
2. The “\_” in the commands cannot omit. Parameter: %d: 0 means ALL.
3. Command head & Parameter1 & Parameter2... need to add one “SPACE”.

**The following table is only an example. Please refer to the list of instructions.**

Instruction description	instruction	parameter 1	parameter 2	parameter 3
Video switch	#video_%c	out%d	in%d	matrix=%d
Audio Mode Switch	#audio_%c	in%d	/	enc=%d
EDID	#EDID_%c	In%d	cfg=%d	/

Please refer to the " Command list" for details.

Example: ALL output switches to input 4.

Operation format: #video\_d out0 matrix=4

## 12. Web Control

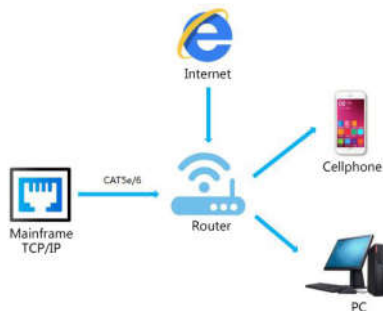

- 1). Connect the Ethernet port of matrix to the Ethernet port on PC by a crossover cable with RJ45 connectors.
- 2). Configure your PC as follows:
  - ① Click **Start > Control Panel > Network and Sharing Center.**
  - ② Click **Change Adapter Settings.**
  - ③ Highlight the network adapter you want to use to connect to the device and click **Change settings of this connection.**
- 3). The local Area commotion properties window for Network selection appears as below:
- 4). Click the Highlight **Internet Protocol Version 4 (TCP/IPv4).**
- 5). Click **Properties.**
- 6). Select **Use the following IP Address** for static IP addressing and fill in the details.

For TCP/IPv4 you can use any IP address in the range 192.168.1.1 to 192.168.1.255 (excluding 192.168.1.168).

7). Click **OK.**

8). Click **Close.**

**Default IP Address: 192.168.1.168**

**MASK: 255.255.255.0**

**Gateway:192.168.1.1**

**MAC:0008-DCCA-CF3F**

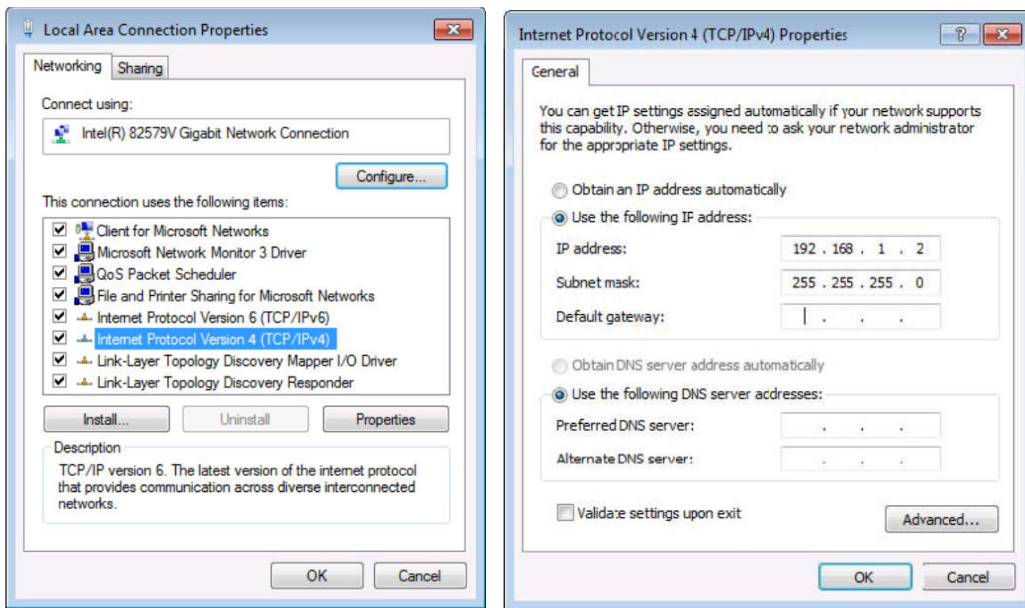

### 12.1. Enter Web and Control

Enter the default IP address of the matrix: 192.168.1.168

Account: admin

Password: admin

### 12.2. “Status” interface:

#### Input Info & Output Info & Device Info:

1. CONNECT: The input status display bar. After connecting with the device, it will check whether the current input terminal has access signal source.

When no signal source connected, it will be displayed as "×", and when there is a normal working signal source connected, it will be displayed as "√".

2. AUDIO-EMBED: The Audio Embed status display bar. After connecting with the device, it will check whether the current HDMI output terminal has Audio Embed.

When audio is not embedded, it will be displayed as "×". When audio is embedded, it will be displayed as "√".

3. Connect (Local) and (Remote): It will be displayed as "X" when there is no display device access, and "√" when there is display device access.

4. Audio De-Embed: Indicates if Audio separation is turned on. "X": means off. "√": means on

5. Audio HDMI & UTP: Indicates if the current local (HDMI) / Remote (UTP) Audio output is available. When the HDMI/UTP Audio output is turned off, displayed as "×", and when the HDMI/UTP Audio output is turned on, displayed as "√".

6. POC (Remote): “ON” “OFF” means POC turned on or off

7. HTML Version: Current WEB Version

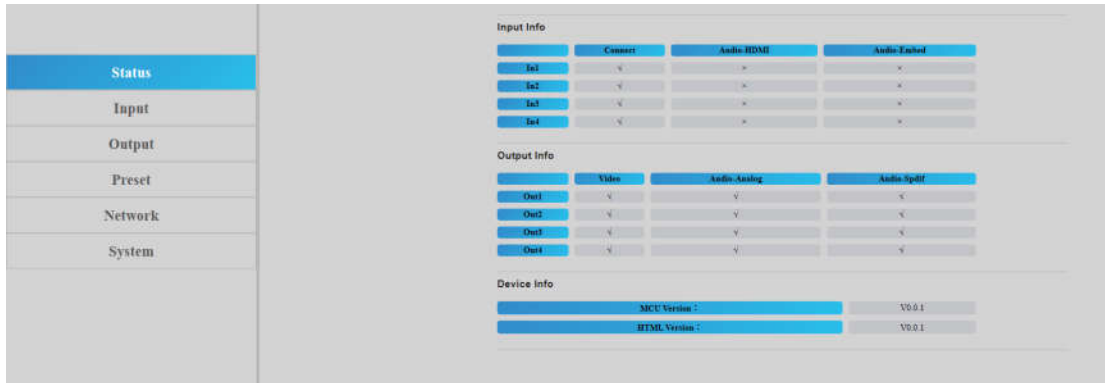

### 12.3. “Input” interface:

Noted: Double Click the Rename column can change the name of the ports.

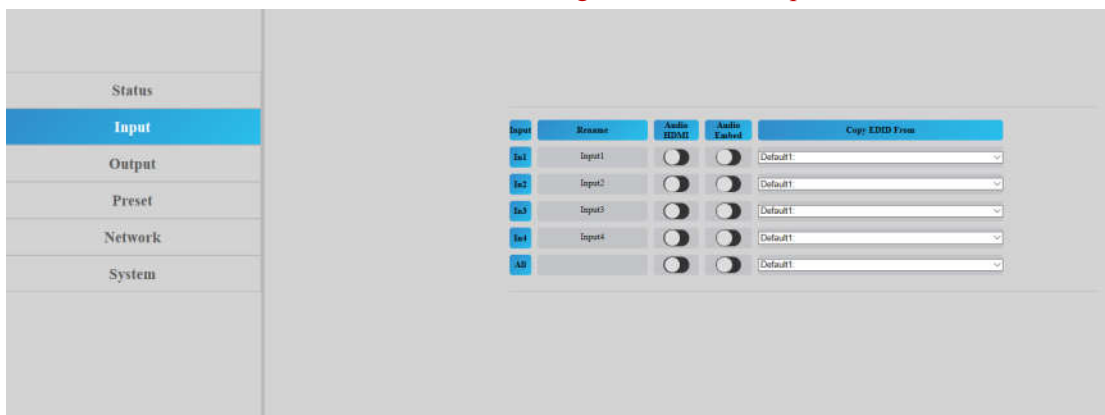

### 12.4. “Output” interface:





12.5. “Preset” interface:

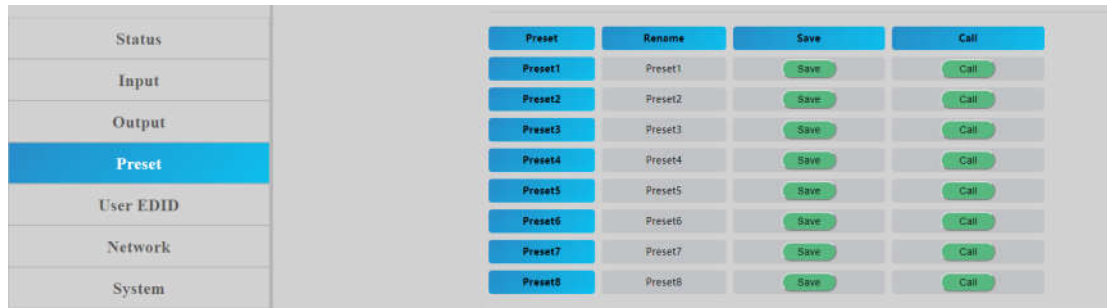

12.6. “Network” interface:



12.7. “System” interface:

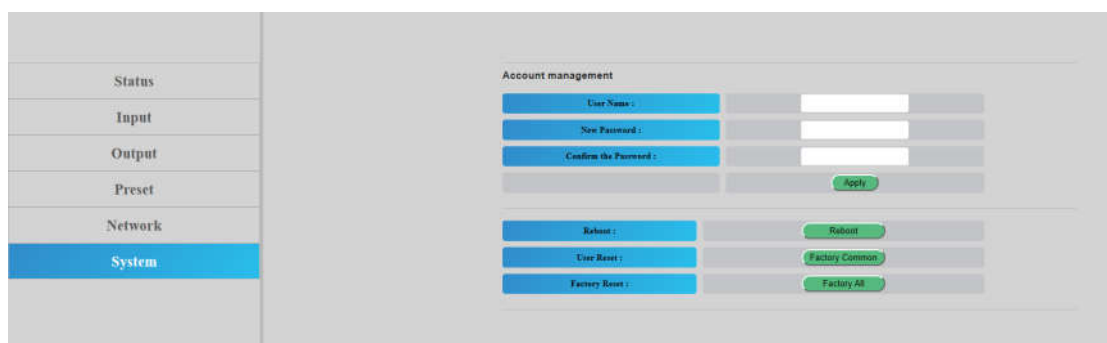

### 13. FW UPGRADE

First upgrade MCU (layer of application) and then upgrade CPLD, finally upgrade HTML (web page), (CPLD, HTML, MCU all support to use USB Micro port for upgrading)

- A1 means MCU
- A1 01 means GUI
- C0 means CPLD
- F0 means HTML

#### 13.1. MCU Upgrade:

Open the software UART\_ISP\_V1.6.exe on PC, select the correct port and baud rate 115200, enter "A1" in Port, then select the path of the program in PATH (XXX. Bin), and click UPDATA to complete the upgrade

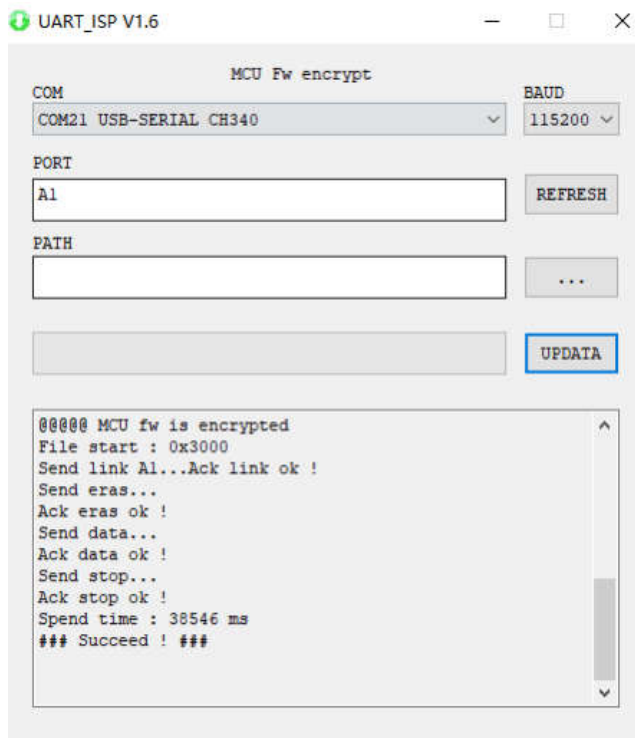

#### 13.2. CPLD Upgrade:

Open the software UART\_ISP\_V1.6.exe on PC, select the correct port and baud rate 115200, enter "C0" in Port, then select the path of the program (XXX. VME) in PATH, and click UPDATA to complete the upgrade

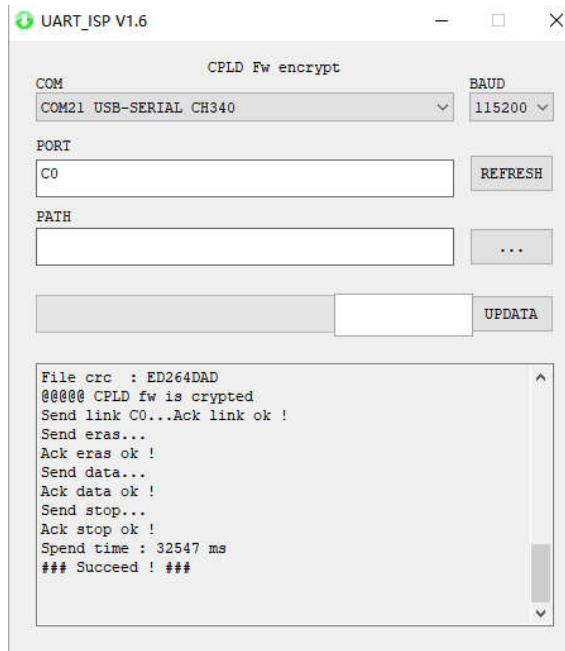

### 13.3. HTML (WEB GUI) Upgrade:

Open the software UART\_ISP\_V1.6.exe on PC, select the correct port and baud rate 115200, enter "F0" in Port, then select the path of the program (XXX. HTML) in PATH, and click UPDATA to complete the upgrade

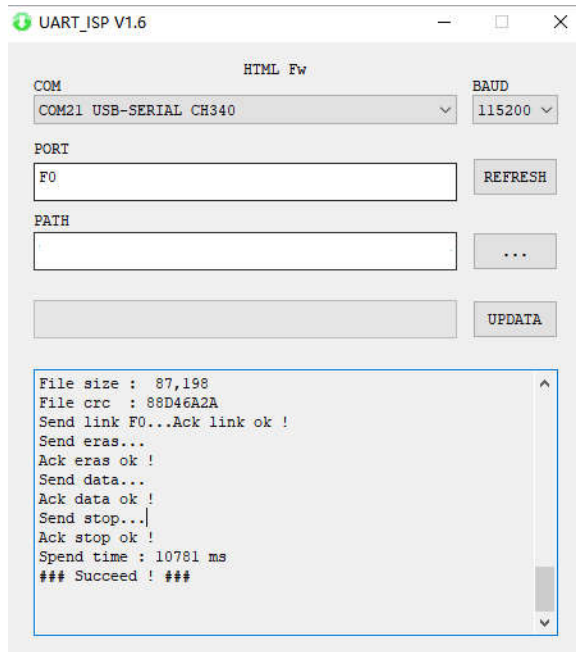

## MAINTENANCE

Clean this unit with a soft, dry cloth. Never use alcohol, paint thinner or benzene to clean this unit.

## PRODUCT SERVICE

(1) **Damage requiring service:**

The unit should be serviced by qualified service personnel if:

- (a) The DC power supply cord or AC adaptor has been damaged;
- (b) Objects or liquids have gotten into the unit;
- (c) The unit has been exposed to rain;
- (d) The unit does not operate normally or exhibits a marked change in performance;

The unit has been dropped or the cabinet damaged.

(2) **Servicing Personnel:** Do not attempt to service the unit beyond that described in these operating instructions. Refer all other servicing to authorized servicing personnel.

(3) **Replacement parts:** When parts need replacing ensure the servicer uses parts specified by the manufacturer or parts that have the same characteristics as the original parts. Unauthorized substitutes may result in fire, electric shock, or other Hazards.

(4) **Safety check:** After repairs or service, ask the servicer to perform safety checks to confirm that the unit is in proper working condition.

The logo for DIREKTRONIK is displayed in a bold, italicized, sans-serif font. The letters are white with a thick red outline. The logo is positioned on a yellow curved background that sweeps across the bottom of the page.