



X21s

Four-Relay (SPDT) Expansion Module

USERS MANUAL

Revision 1.0

For models: X-21s

4 Relays (SPDT) • Removable Connector



- ▶ Indicator Lights
- ▶ Door Locks
- ▶ Gate Control
- ▶ Interface with a PLC

DIREKTRONIK

Dataprodukter utöver det vanliga

CONTROL by
WEB™
www.ControlByWeb.com

a division of Xytronix Research & Design, Inc.
located in Nibley, Utah, USA

© 2019 Xytronix Research and Design, Inc.

X-21s User Manual Revisions	
Revision	Description
1.0	Initial release

Section 1: Introduction

The X-21s™ 4 SPDT Relay expansion module is used with the X-400/X-600M controller. The X-21s has four relays, each with Form-C contacts (SPDT) that are accessed through a removable terminal connector. One or more X-21s expansion modules can be connected to an X-400/X-600M controller with a ribbon cable. The ribbon cable provides both power and communications to the expansion modules.

The X-400/X-600M controller modules are multi-function web-enabled industrial I/O controllers. They perform control, logic, and monitoring functions similar to that of a Programmable Logic Controller (PLC). However, unlike a PLC, these controllers are designed for web-based applications from the ground up.

No add-on software or hardware is required. The controller modules can be fully configured, programmed and tested using its built-in web server. The web setup pages are intuitive and easy to use and do not require special programming skills.

The X-400/X-600M controllers, together with expansion modules such as the X-21s provide an easy, flexible and reliable way to monitor and control systems and devices over a network. The X-21s is suitable for use with moderate loads such as solenoid valves, alarms and indicator lights.



1.1 Connectors & Indicators

Relays

The X-21s has four relays. Terminals are provided for the *Common, Normally Open, and Normally Closed* contacts of each relay. A 12-position plug-in screw terminal is used to make it easy to wire the device. The terminals are wired directly to the internal relays with no internal fuse or other over-current protection. The relays are isolated from all other circuits inside. When a relay coil is energized, the NO contacts are closed and the NC contacts are opened. The load device that is connected to the relay contacts will be on when the coil is energized.

Expansion Bus

The expansion bus allows a variety of expansion modules to be connected directly to the X-400/X-600M controllers. The modules connect directly to the controller using a ribbon cable rather than through an Ethernet switch. The cable can be a daisy chain with multiple connectors. The ribbon cable expansion

bus provides both power and communications connections.

Power Supply

The expansion bus can provide up to 1.7 Amps for powering up to 32 expansion modules; however, the maximum number of expansion modules depends on the module type and power source attached to the controller. The X-21s requires relative high current to operate the relays and the 1.7 Amp limit will be reached long before 32 modules are attached. To overcome this limitation an expansion bus power injector can be put inline on the expansion bus. See the [Power Requirements](#) section in Appendix A for current draw for the X-21s under different configurations.

The X-21s employs a modern switch-mode power supply. With this type of power supply the current draw decreases as the voltage increases; therefore, you can add more expansion modules by using a 24-volt power supply than you can with a 12-volt power supply. See the [X-600M](#) or [X-4xx series User Manual](#) for more details.

Indicators

The green, power LED indicator is illuminated whenever the module is powered. To identify the module during installation the controller can send a blink command which will cause the power LED to blink for three seconds. The 4 yellow LEDs indicate the status of the relays and are illuminated when the respective relay coils are energized.

1.2 Part Numbers and Accessories

Device	Description	Part Number
X-21s	4-Relay (SPDT) Expansion Module	X-21s
Spare Connector	12-Position Screw Terminal Connector	X-1803675

Section 2: Installation and Connections

Installation consists of mounting the X-21s and connecting it to an X-600M or X-400 controller with a 10-conductor ribbon cable. Programming and testing is done by using a web browser to configure the relays for your specific needs.

2.1 Installation Guidelines

- This unit must be installed by qualified personnel.
- This unit must not be installed in unprotected outdoor locations.
- This unit must not be used for medical, life saving purposes, or for any purpose where its failure could cause serious injury or the loss of life.
- This unit must not be used in any way where its function or failure could cause significant loss or property damage.

This equipment is not rated for installation within or as part of a circuit breaker panel. When used to control AC line voltages the X-21s must be mounted and protected in a suitable electrical enclosure.

2.2 Mounting

X-21s can be mounted to a standard (35mm by 7.55mm) DIN-Rail. Normally expansion modules are mounted to the left side (embossed logo side of the enclosure) of the X-600M or X-400 controller so that the ribbon cable doesn't cover the power connector. The X-21s should be located in a clean, dry location where it is protected from the elements. Ventilation is recommended for installations where high ambient air temperatures are expected to be high. See *Appendix A: Mechanical Information* for additional mechanical details.



2.2.1 DIN-Rail Mounting

Attach the X-21s to the DIN-Rail by hooking the top hook on the back of the enclosure to the DIN-Rail and then snap the bottom hook into place. To remove the X-21s from the DIN-Rail, use a flat-head screwdriver. Insert the screw driver into the notch in the release tab and pry against the enclosure to release the bottom hook.

2.3 Making Connections

CAUTION: Make sure the power is shut off before making connections

CAUTION: This unit should be installed by a qualified technician.

CAUTION: Miswiring or misconfiguration could cause permanent damage to the X-21s, the equipment to which it is connected, or both.

The correct wiring procedure is as follows:

1. Make sure power is turned off.
2. Remove the terminal connector from the X-21s and make wiring connections to the terminals. This technique avoids stressing the internal components while torquing the screws.
3. Reconnect the terminal connector.
4. Apply power.

It is recommended that any load (device to be controlled) not be connected to the expansion modules until after the X-600M or X-400 has been configured and tested. By doing this, wiring and configuration mistakes will not cause the load device to turn on unexpectedly.

12-Pin Connector Pinout	
Terminal	Description
4NC	Relay 4 Normally Closed
4C	Relay 4 Common
4NO	Relay 4 Normally Open
3NC	Relay 3 Normally Closed
3C	Relay 3 Common
3NO	Relay 3 Normally Open
2NC	Relay 2 Normally Closed
2C	Relay 2 Common
2NO	Relay 2 Normally Open
1NC	Relay 1 Normally Closed
1C	Relay 1 Common
1NO	Relay 1 Normally Open

Make certain the wires are properly inserted into to the terminals and that the screws are tight.

Wire Specification:

Use wire rated for 75°C (min) for connections to the terminal blocks

Connector Specifications:

Type:	12-position, removable, 3.81 mm pitch
Connection wire:	Use wire rated for 75°C (min) for connections to the terminal blocks
Stripping Length:	7mm
Connection capacity:	1.5mm ² stranded, 1.5mm ² solid
Conductor minimum:	30AWG (UL/CUL)
Conductor maximum:	14 AWG (UL/CUL)
Conductor Type:	Copper
Tightening torque:	0.22 Nm (min), 0.25 Nm (max)

Section 3: Example Applications

3.1 Control a device over an IP network

The illustration below shows a simple example of using the X-21s to control a device over an IP network. The device to be controlled is wired in series with the relay contacts.

Note: A fuse or circuit breaker is shown to limit current overload.

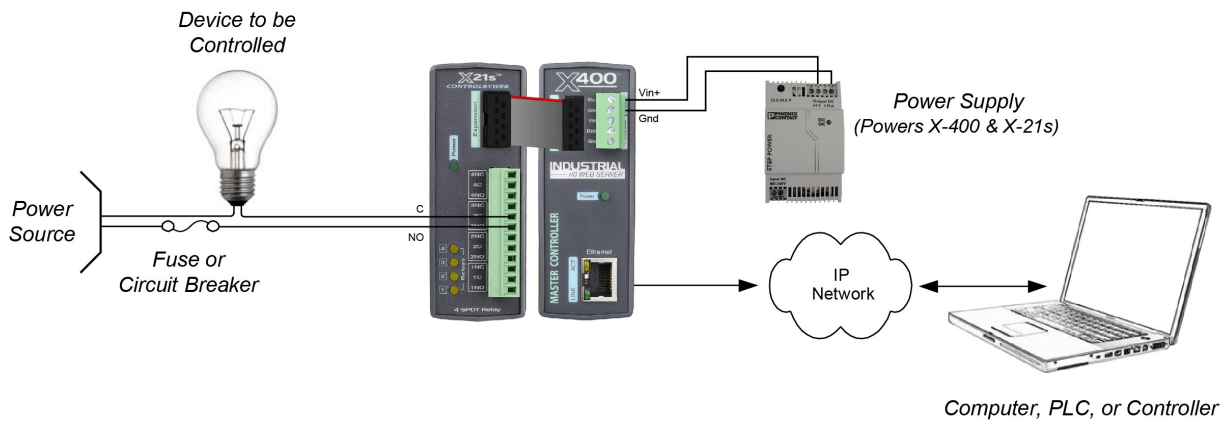

3.2 High Current Relay

The illustration below shows an example of how the X-21s is used to control an AC motor. A high-current relay is used to switch the load current to the motor. In this example a MOV (Metal Oxide Varistor) is used to help protect the relay contacts of the X-21s from arc damage. Under normal conditions the resistance of the MOV is very high. When a spike or surge occurs, the resistance of the MOV drops and shunts the high voltage transients.

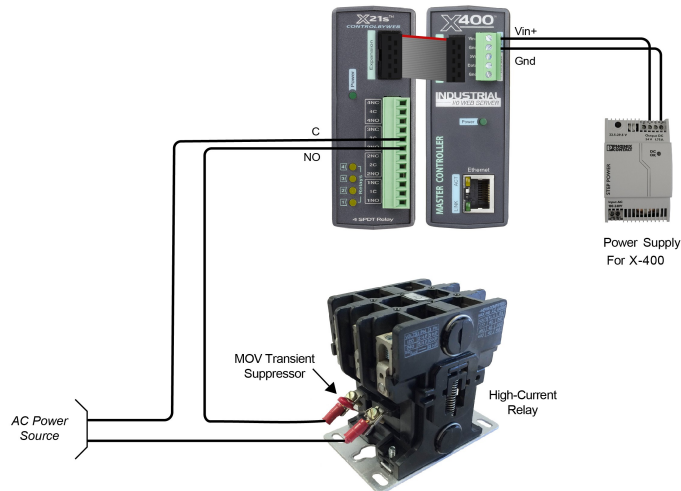

Section 4: Configuration and Setup

4.1 Setup Example with the X-400 Controller

After making the power and Ethernet connections, the X-400 can automatically scan for the presence of any ControlByWeb™ Ethernet devices (on the same sub-net) and also for any expansion modules connected to the X-400 via the ribbon-cable connector.

To quickly add a device, do the following:

1. Click on the **Devices** menu tab to pull up the *Devices Overview* page. Then click on the **Find Devices** button to scan the expansion bus and the local network for ControlByWeb devices and expansion modules.

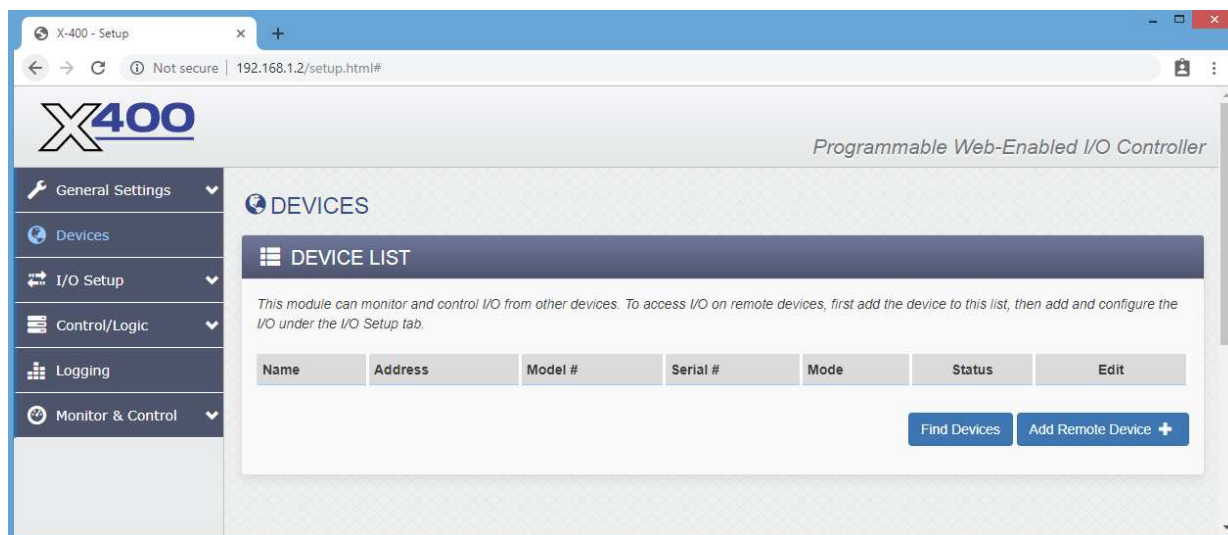

2. In this example we are going to add an X-21s 4 Relay Expansion Module. Click the **Add** button for the X-21s.

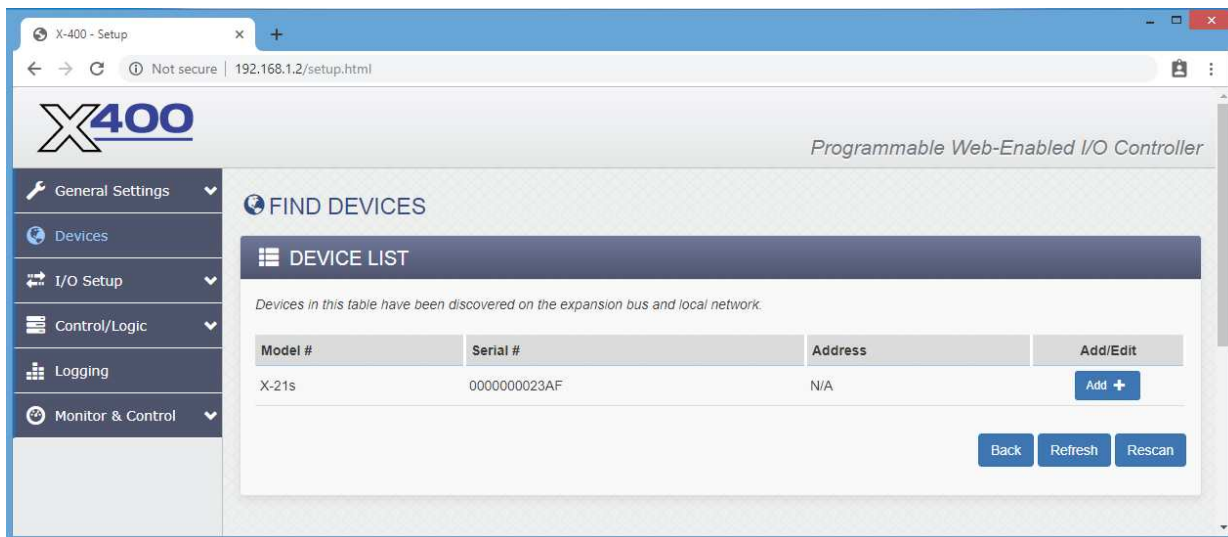

3. In the **Device Name** field, name your device. Then click **Add Device**.

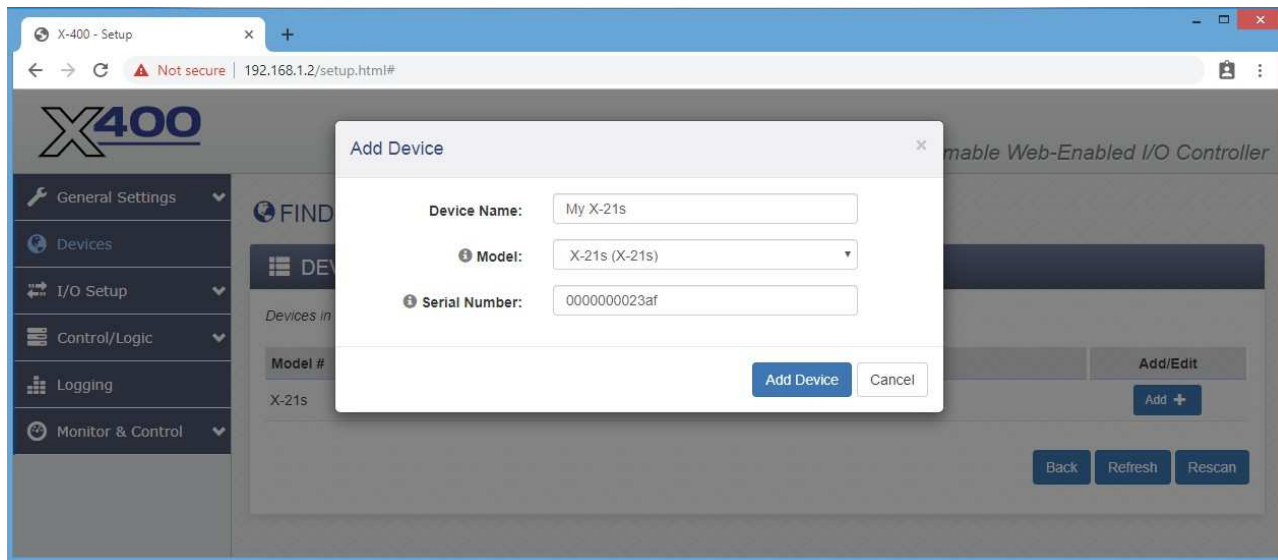

4. In the *Add I/O* column, click the check boxes of the I/O components you would like to configure.

Click **Add Selected I/O** to submit these changes.

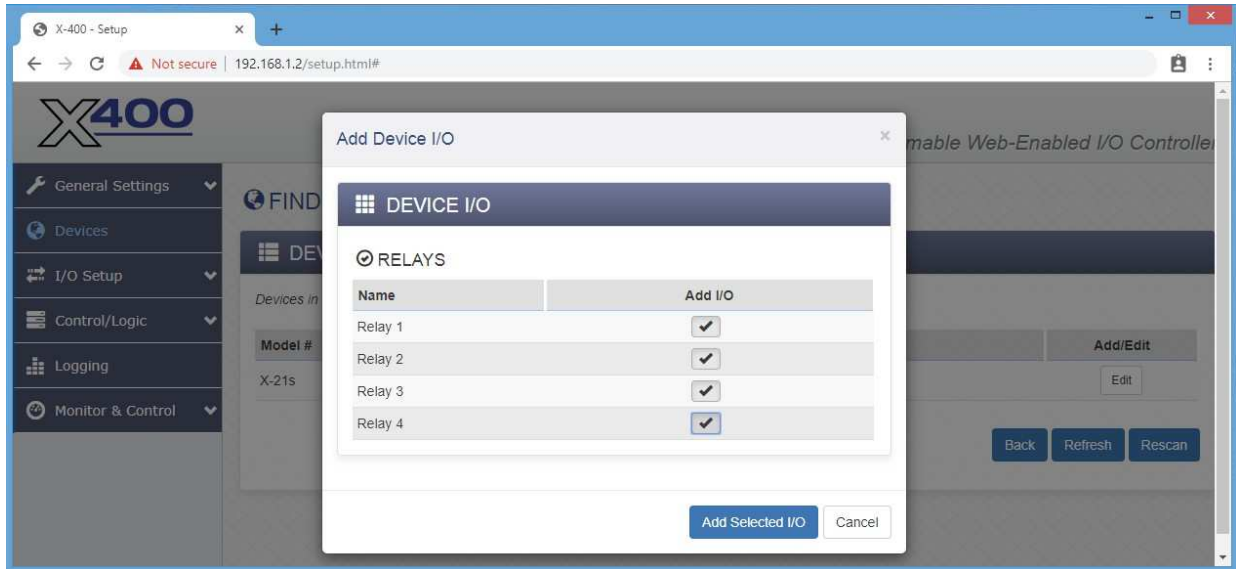

5. Click on the **Monitor & Control** menu tab, then click on the Control Page Setup tab to configure what will appear on the Control Page.

6. Click **Add I/O to Control Page**.

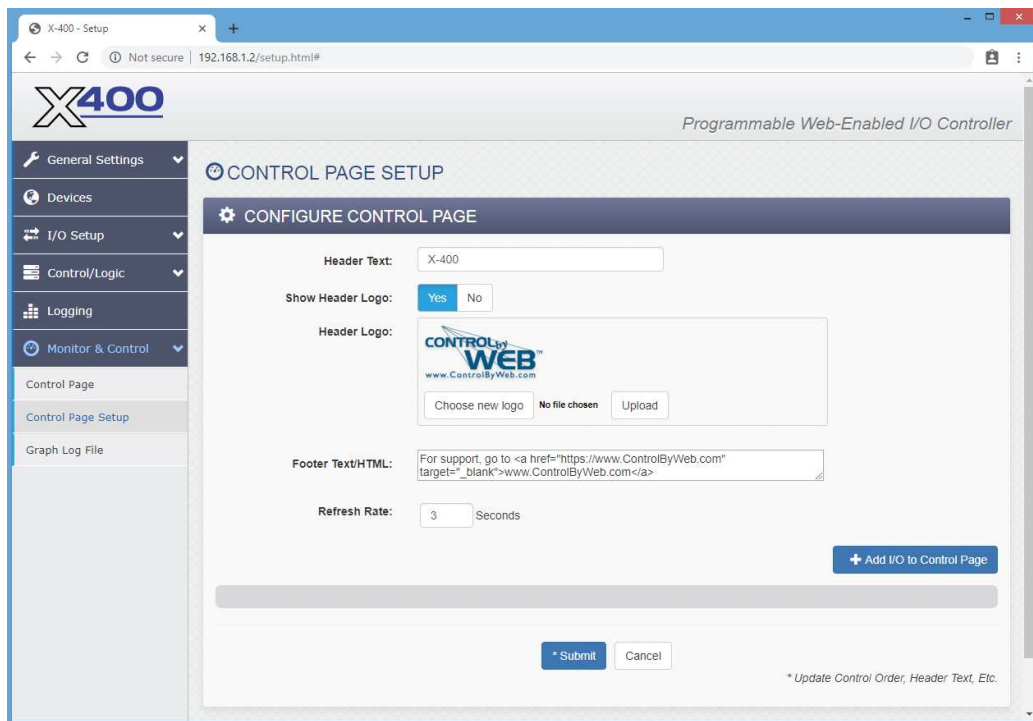

7. Click the check boxes of the I/O you would like to add to the control panel, then click **Add I/O** to submit these changes.

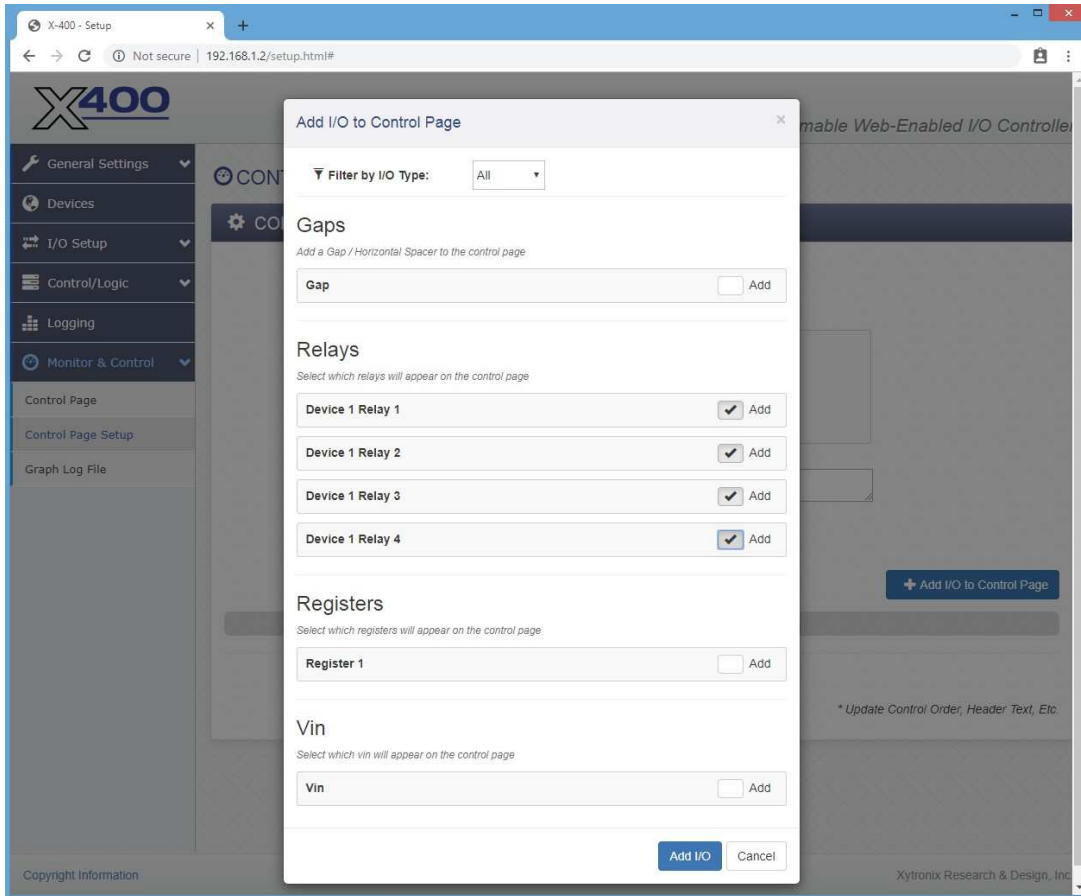

8. On the main menu, click the **Control Page** menu tab. The **Control Page** tab shows the relays that were just added along with their current states. The relays can be turned on, off, and pulsed from this page.



4.2 Setup Example with the X-600M Controller

The Quick Start Demo

After making the power and Ethernet connections, the X-600M can automatically scan for the presence of any ControlByWeb™ Ethernet devices (on the same sub-net) and also for any expansion modules connected to the X-600M via the ribbon-cable connector. It also automatically creates a dashboard web page and populates it with all of the resources (components) supported by the Ethernet devices and expansion modules. This makes it easy to start experimenting with the web page's user interface and to try out the relays and sensors.

To quickly add a device, do the following:

1. Click on the **Devices** menu tab to pull up the *Devices Overview* page. Then click on the **Find New Devices** button to scan the expansion bus and the local network for ControlByWeb devices and expansion modules.

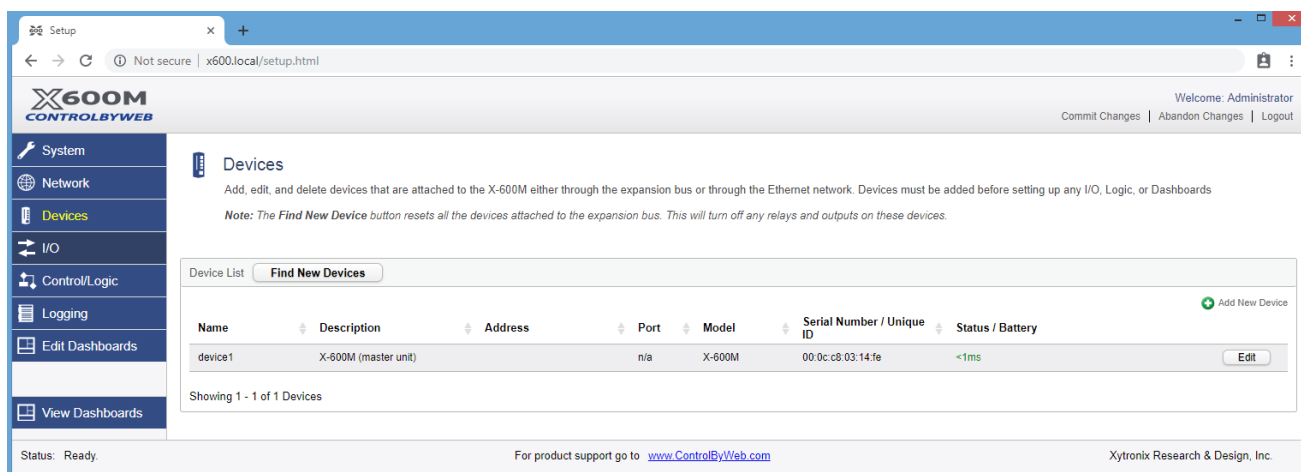

The screenshot shows the X-600M ControlByWeb web interface. The browser address bar shows 'x600.local/setup.html'. The page title is 'X-600M CONTROLBYWEB'. The user is logged in as 'Administrator' and can 'Commit Changes', 'Abandon Changes', or 'Logout'. The left sidebar has a 'Devices' menu item highlighted. The main content area is titled 'Devices' and contains instructions: 'Add, edit, and delete devices that are attached to the X-600M either through the expansion bus or through the Ethernet network. Devices must be added before setting up any I/O, Logic, or Dashboards'. A note states: 'Note: The Find New Device button resets all the devices attached to the expansion bus. This will turn off any relays and outputs on these devices.' Below this is a 'Device List' table with a 'Find New Devices' button and an 'Add New Device' button. The table has columns: Name, Description, Address, Port, Model, Serial Number / Unique ID, and Status / Battery. One device is listed: 'device1' with description 'X-600M (master unit)', port 'n/a', model 'X-600M', serial number '00:0c:c8:03:14:fe', and status '<1ms'. An 'Edit' button is next to the device entry. The footer shows 'Status: Ready', 'For product support go to www.ControlByWeb.com', and 'Xytronix Research & Design, Inc.'

Name	Description	Address	Port	Model	Serial Number / Unique ID	Status / Battery
device1	X-600M (master unit)		n/a	X-600M	00:0c:c8:03:14:fe	<1ms

2. In this example we are going to add an *X-21s (SPDT) 4 Relay expansion module*. Click the **Add** button for the X-21s.

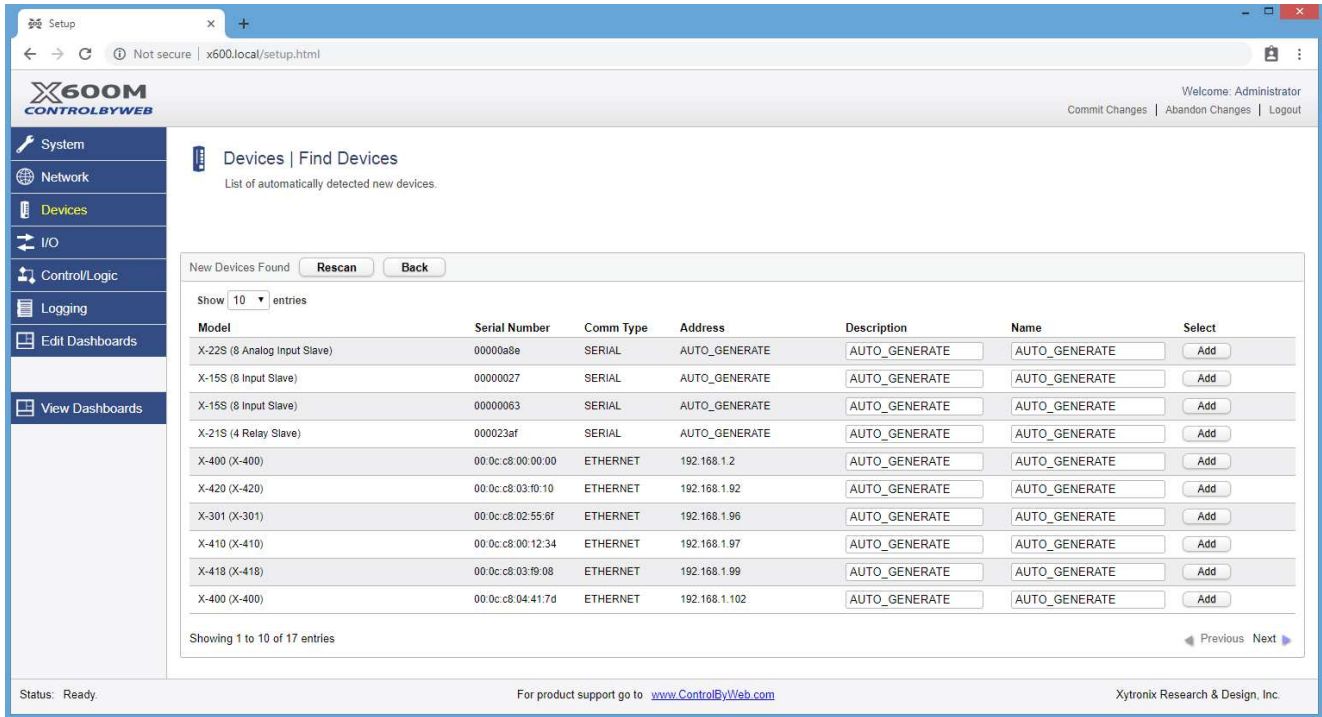

3. In the *Select* column, click the check boxes of the I/O components you would like to configure and select the **Create Device Widget** checkbox (This will automatically add the status of the I/O to the Dashboard).

Click **Add Checked I/O** to submit these changes.

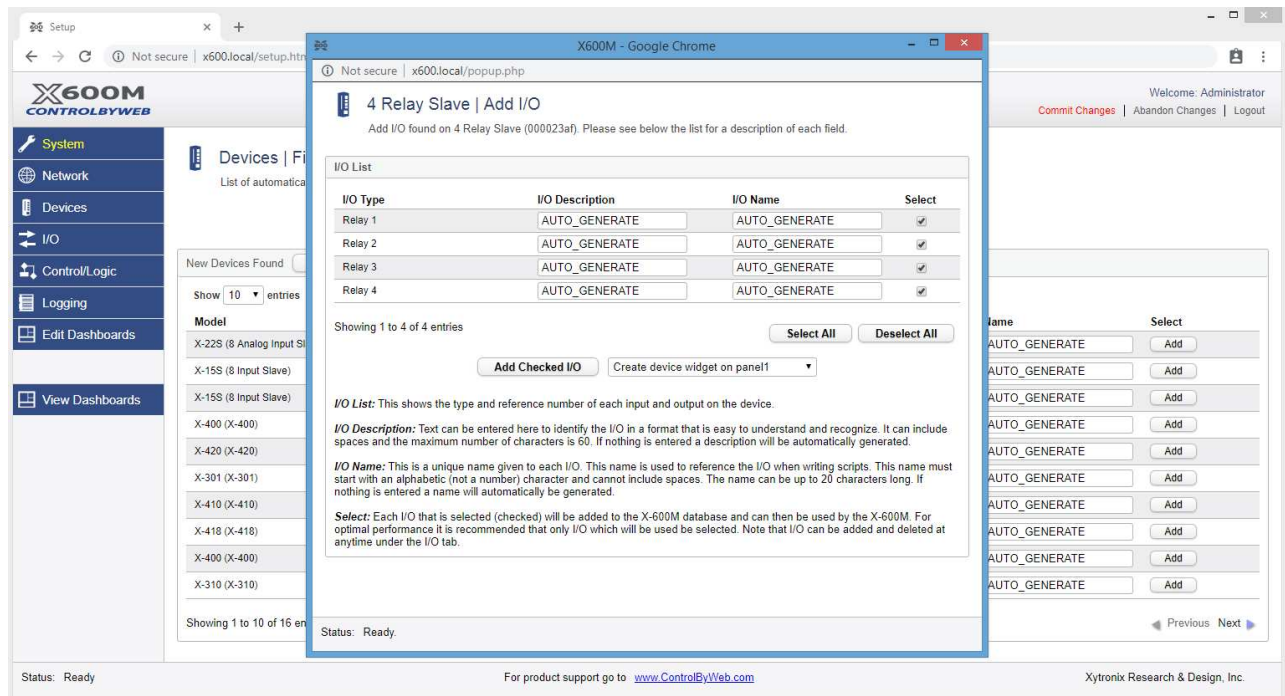

4. Click **Commit Settings**. Once clicked, the X-600M begins to monitor the newly added device.

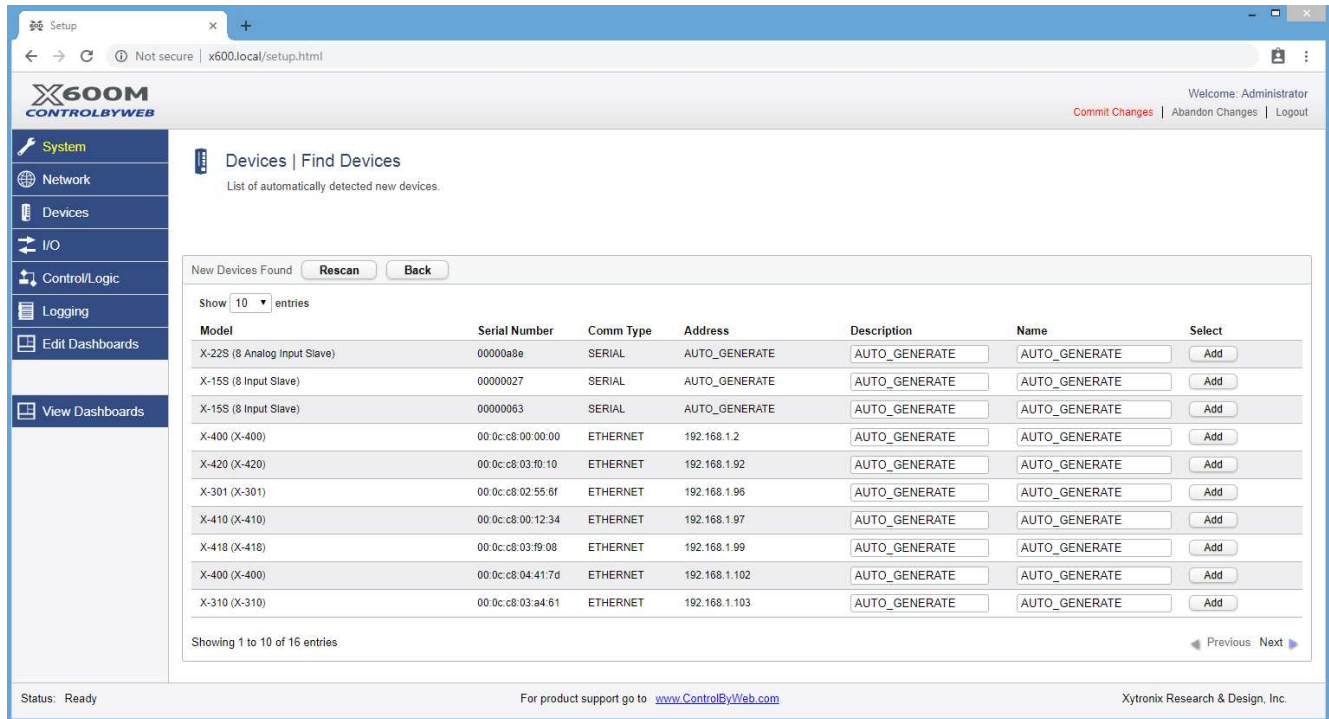

5. On the main menu, click the **View Dashboards** menu tab. The **View Dashboards** page shows a display similar to what users will see when accessing the X-600M's Control Page. Use this page to test and debug the dashboards, panels, widgets and components in real time. A pull-down menu allows access to other dashboards. Within minutes you can experience the power and flexibility of the dashboard's user interface and experiment/test the buttons, sliders, and data entry boxes to meet your needs for your specific application.

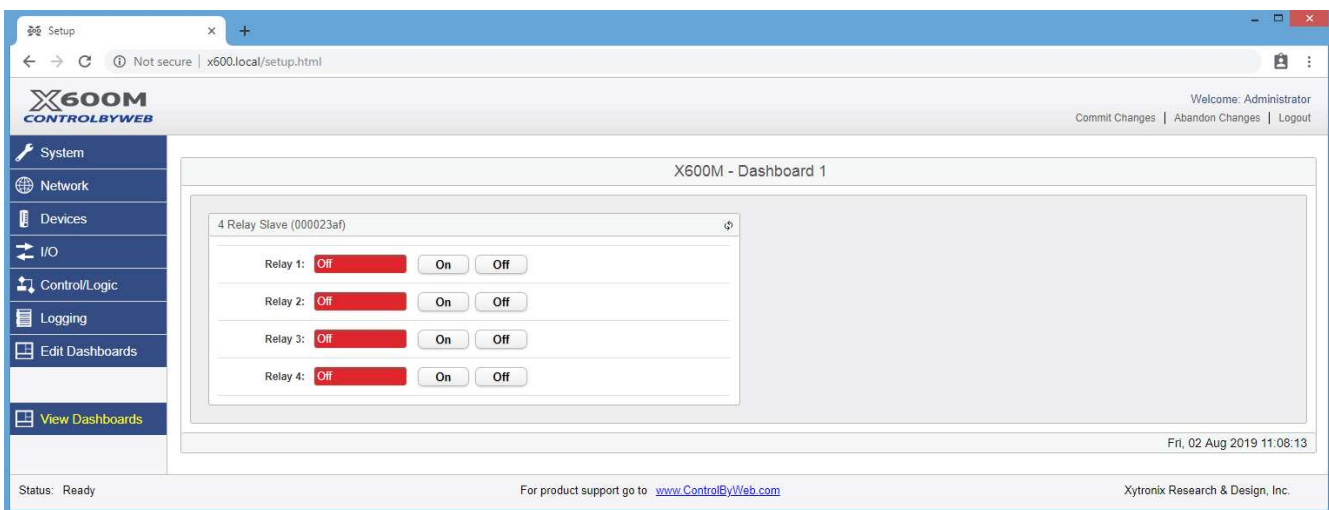

Appendix A: Specifications

Power Requirements

Input Voltage: 9-28 VDC (power is supplied via the X-400 or X-600M controller, 24V recommended)
 Current: See table below for typical values at 25°C

Power Supply	Relays OFF	Relays ON
9 VDC	17 mA	270 mA
12 VDC	13 mA	189 mA
24 VDC	7 mA	110 mA

Relays

Number of relays: 4

Relay Contacts

Load Type: General purpose
 Contact Form: SPDT (1 form C)
 Contact Material: Silver nickel
 Max Voltage: 125VAC, 28VDC
 Max Current: 2.5A (per relay)
 Electrical Life: 100K cycles, typical @ rated load
 Environmental Rating: Over voltage Category II, Pollution Degree 2
 Control Options: On/Off, Pulse and Toggle
 Pulse Timer Duration: 100ms to 86400 Seconds (1-day)

Relay Connector

Type: 12-position, removable, 3.81 mm pitch
 Connection wire: Use wire rated for 75°C (min) for connections to the terminal blocks
 Stripping Length: 7mm
 Connection capacity: 1.5mm² stranded, 1.5mm² solid
 Conductor minimum: 30AWG (UL/CUL)
 Conductor maximum: 14 AWG (UL/CUL)
 Conductor Type: Copper
 Tightening torque: 0.22 Nm (min), 0.25 Nm (max)

(Replacement part number, Phoenix Contact 1803675)

Expansion Connector:

Connector: Ribbon cable, 2x5-position, polarized 0.100" pitch
 Communications: RS-485

LED Indicators

Green: Power On
 Yellow: Relay 1 thru 4

Environmental

Indoor use or NEMA-4 protected location
 Altitude: Up to 2000m
 Operating Temperature: -40°C to 65.5°C (-40°F to 150°F)
 Storage Temperature: -40°C to 85°C (-40°F to 185°F)
 Humidity: 5-95%, non-condensing

Mechanical

Size: 1.41 x 3.88 x 3.1 in. (35.7 x 98.5 x 78 mm), (not including connector)
Weight: 4.8 oz (136 g)

Electromagnetic Compliance

IEC CISPR 22, CISPR 24
FCC 47CFR15 (Class B)
EN55024 ITE Immunity (2010)
EN55022 Emissions (2010)

Product Safety Compliance

IEC 61010-1 (Electrical Equipment for Measurement, Control, and Laboratory Use)



Appendix B: Trademark and Copyright Information

This document is Copyright ©2019 by Xytronix Research & Design, Inc. All rights reserved.

X-21s™, X-400™, X-600m™, WebRelay™, ControlByWeb™, and Xytronix Research & Design™ are trademarks of Xytronix Research & Design™, Inc. 2005-2019.

All other trademarks are the property of their respective owners.

All parts of this product and design including but not limited to firmware, hardware design, schematics, PCB layout, concept, graphics, users manual, etc., are property of Xytronix Research & Design, Inc. ©2005-2019. X-21s™ may not be opened, disassembled, copied or reverse-engineered.

No part of this manual may be reproduced or transmitted in any form or by any means, electronic or mechanical, including photocopying or scanning, for any purpose other than the personal use by the purchaser of this product. Xytronix Research & Design, Inc., assumes no responsibility for any errors that may appear in this document.

Whereas reasonable effort has been made to make the information in this document as useful and accurate as possible, Xytronix Research & Design, Inc. assumes no responsibility for the application, usefulness, or completeness of the information contained herein. Under no circumstance will Xytronix Research & Design, Inc. be responsible or liable for any damages or losses including direct, indirect, special, incidental, or consequential damages or losses arising from either the use of any information contained within this manual or the use of any products or services referenced in this manual.

Xytronix Research & Design, Inc. reserves the right to change any product's features, specifications, documentation, warranties, fee schedules, and conditions at any time and without notice.

Appendix C: Warranty

This Xytronix Research & Design, Inc. product is warrantied against defects in material and workmanship for a period of five years from the date of shipment. During the warranty period, Xytronix Research & Design, Inc. will, at its option, either repair or replace products that prove to be defective. This warranty is extended to the original purchaser of the equipment only.

For warranty service or repair, the customer must contact Xytronix Research & Design, Inc. technical support (support@ControlByWeb.com) and obtain a Return Authorization number (RA#). Before issuing an RA#, a support technician will work with customer to try to resolve the issue without returning the product. If technician determines that product must be returned for service an RA# will be issued. Next, the product must be properly packaged and returned to Xytronix Research & Design, Inc. with the RA# clearly marked on the package. The purchaser shall prepay all charges for shipping to Xytronix Research & Design, Inc. For warranty repairs of products less than one year old, Xytronix Research & Design, Inc. will pay the shipping charges to return the product to the purchaser as long as the product is shipped within the continental United States. If the product is shipped outside of the continental United States or the product was shipped more than one year earlier, the purchaser shall pay all shipping charges both ways.

Limitation

The foregoing warranty shall not apply to defects or damage resulting from improper use or misuse, unauthorized repair, tampering, modification, improper connection, or operation outside the electrical/environmental specifications for the product. Further, the warranty does not cover damage from Acts of God, such as lightning, fire, flood, hurricanes and tornadoes. This warranty does not cover damage to property, equipment, direct, indirect, consequential, or incidental damage (including damage for loss of business profit, business interruption, loss of data, and the like) arising out of the use or misuse of this product.

UNDER NO CIRCUMSTANCES WILL THE LIABILITY OF XYTRONIX RESEARCH & DESIGN, INC. TO THE PURCHASER OR ANY OTHER PARTY EXCEED THE ORIGINAL PURCHASE PRICE OF THE PRODUCT, REGARDLESS OF THE FORM OF THE CLAIM. No other warranty is expressed or implied. Xytronix Research & Design, Inc. specifically disclaims the implied warranties or merchant-ability and fitness for a particular purpose. Some jurisdictions may not allow the exclusion of limitation of liability for consequential or incidental damage.

Appendix D: FCC Statement

This device complies with Part 15 of the FCC Rules. Operation is subject to the following two conditions:

- This device may not cause harmful interference.
- This device must accept any interference received, including interference that may cause undesired operation.

Warning

This equipment has been tested and found to comply with the limits for a Class B digital device, pursuant to Part 15 of the FCC Rules. These limits are designed to provide reasonable protection. This equipment generates, uses and can radiate radio frequency energy and, if not installed and used in accordance with the instructions, may cause interference to radio communications. There is no guarantee, however, that interference will not occur in a particular installation. If this equipment does cause harmful interference to radio or television reception, which can be determined by turning the equipment off and on, the user is encouraged to try to correct the interference by one or more of the following measures:

- Reorient or relocate the receiving antenna.
- Increase the separation between the equipment and receiver.
- Connect the equipment into a relay on a circuit different from where the receiver is connected.
- Consult the dealer or an experienced radio/TV technician for help.

Notice

Changes or modification not expressly approved by the party responsible for compliance could void the user's authority to operate the equipment.

Appendix E: Mechanical Dimensions

