

Milesight

DIREKTRONIK

Magnet Contact Switch

Featuring LoRaWAN[®]

WS301

User Guide



Safety Precautions

Milesight will not shoulder responsibility for any loss or damage resulting from not following the instructions of this operating guide.

- ❖ The device must not be remodeled in any way.
- ❖ In order to protect the security of the device, please change device the password when first configuration. The default password is 123456.
- ❖ Do not place the device close to objects with naked flames.
- ❖ Do not place the device where the temperature is below/above the operating range.
- ❖ Make sure electronic components do not drop out of the enclosure while opening.
- ❖ When installing the battery, please install it accurately, and do not install the reverse or wrong model.
- ❖ The device must never be subjected to shocks or impacts.

Declaration of Conformity

WS301 is in conformity with the essential requirements and other relevant provisions of the CE, FCC, and RoHS.



Copyright © 2011-2022 Milesight. All rights reserved.

All information in this guide is protected by copyright law. Whereby, no organization or individual shall copy or reproduce the whole or part of this user guide by any means without written authorization from Xiamen Milesight IoT Co., Ltd.

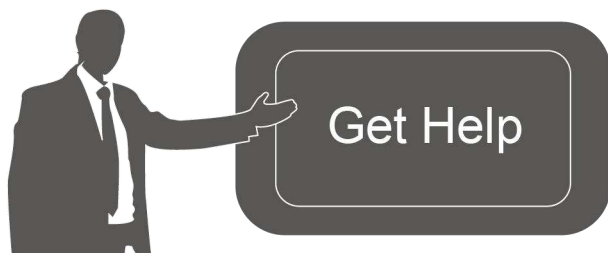

For assistance, please contact

Milesight technical support:

Email: iot.support@milesight.com

Tel: 86-592-5085280

Fax: 86-592-5023065

Address: Building C09, Software Park III,
Xiamen 361024, China

Revision History

Date	Doc Version	Description
Apr. 13, 2021	V 1.0	Initial version
June 30, 2021	V 1.1	Delete power button features
Dec.9, 2021	V 1.2	<ol style="list-style-type: none">1. Add LoRa D2D controller feature;2. Delete low power alarm interval, device only uplinks once when battery level is lower than 10%.

Contents

1. Product Introduction.....	5
1.1 Overview.....	5
1.2 Features.....	5
2. Hardware Introduction.....	5
2.1 Packing List.....	5
2.2 Hardware Overview.....	6
2.3 LED Patterns.....	6
2.4 Dimensions.....	6
3. Operation Guide.....	7
3.1 NFC Configuration.....	7
3.2 LoRaWAN Settings.....	8
3.3 General Settings.....	10
3.4 LoRa D2D Settings.....	11
3.5 Maintenance.....	12
3.5.1 Upgrade.....	12
3.5.2 Backup.....	12
3.5.3 Reset to Factory Default.....	13
4. Installation.....	14
5. Device Payload.....	15
5.1 Basic Information.....	15
5.2 Sensor Data.....	16
5.3 Downlink Commands.....	16

1. Product Introduction

1.1 Overview

WS301 simply enables you to know when someone enters the office/building through a door /window or something has been moved. The minimal magnet is placed inside the portable part, while the sensor is inside the fixed part that can be attached to door/window or other objects. WS301 can be easily mounted on the doors, panes, or cabinets, greatly providing real applications for smart homes, smart offices or smart factories.

Sensor data are transmitted in real-time using the standard LoRaWAN® protocol. LoRaWAN® enables encrypted radio transmissions over long distances while consuming very little power. The user can obtain sensor data and view the trend of data change through Milesight IoT Cloud or through the user's own Application Server.

1.2 Features

- Up to 15 km communication range
- Easy configuration via NFC
- Standard LoRaWAN® support
- Milesight IoT Cloud compliant
- Low power consumption with 1200mAh replaceable battery

2. Hardware Introduction

2.1 Packing List



1 ×

WS301 Sensor



2 ×

Mounting Screws



1 ×

Quick Guide



If any of the above items is missing or damaged, please contact your sales representative.

2.2 Hardware Overview

Sensor:

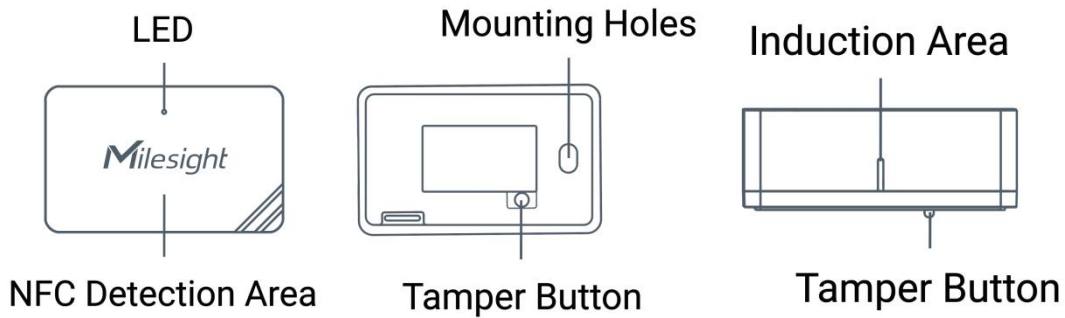

Magnet:

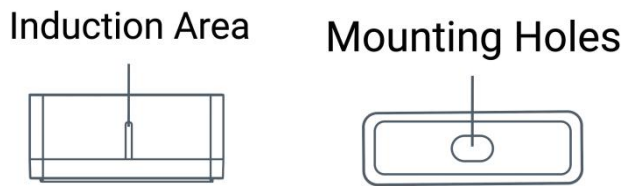

2.3 LED Patterns

Function	Action	LED Indicator
Door/Window Status	Switch On/Off (network unregistered)	Red, blink once
	Switch On/Off (network registered)	Green, blink once
Network Status	Send join network requests	Red, blink once
	Joined the network successfully	Green, blink twice
Tamper Detection	The device is un-installed (tamper is detected)	Red, blink once
	The device is installed	Green, blink once
Reboot	Press and hold the reset button (internal) for more than 3 seconds	Slowly Blinks
Reset to Factory Default	Press and hold the reset button (internal) for more than 10 seconds	Quickly Blinks

2.4 Dimensions (mm)

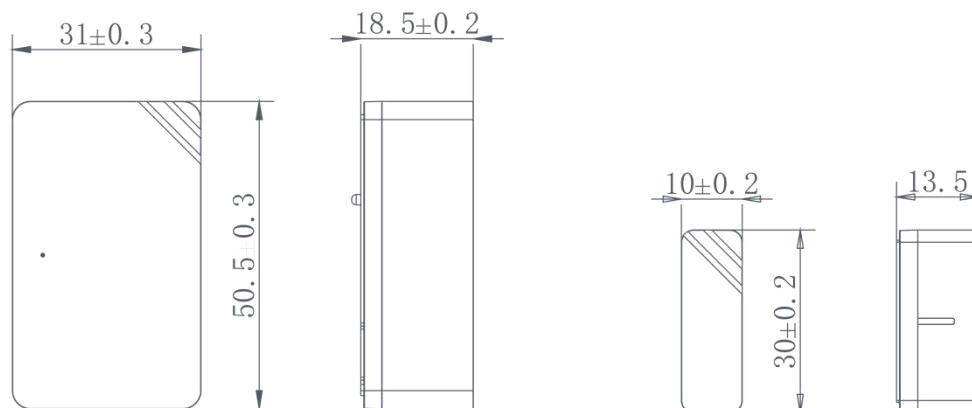

3. Operation Guide

3.1 NFC Configuration

WS301 can be configured via a NFC supported mobile phone.

1. Pull out the battery insulating sheet to power on the device. The indicator will light up in green for 3 seconds when device turns on.

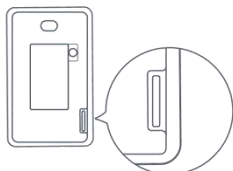

2. Download and install “Milesight ToolBox” App from Google Play or Apple Store.
3. Enable NFC on the smartphone and open Milesight ToolBox.
4. Attach the smartphone with NFC area to the device to read device information.

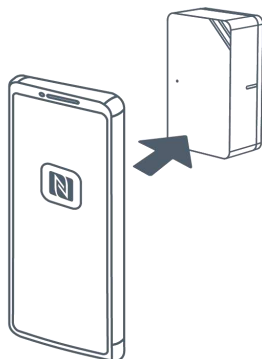

5. Basic information and settings of devices will be shown on ToolBox if it's recognized successfully. You can read and configure the device by tapping the Read/Write button on the App. In order to protect the security of devices, password validation is required when first configuration. The default password is **123456**.

Note:

- 1) Ensure the location of smartphone NFC area and it's recommended to take off phone case.
- 2) If the smartphone fails to read/write configurations via NFC, keep the phone away and back to try again.
- 3) WS301 can also be configured by ToolBox software via a dedicated NFC reader provided by Milesight IoT, you can also configure it via TTL interface inside the device.

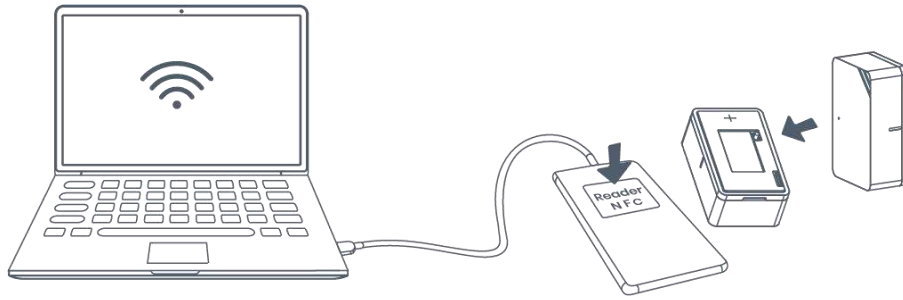

3.2 LoRaWAN Settings

LoRaWAN settings are used for configuring the transmission parameters in LoRaWAN® network.

Basic LoRaWAN Settings:

Go to **Device->Setting->LoRaWAN Settings** of ToolBox App to configure join type, App EUI, App Key and other information. You can also keep all settings by default.

Device EUI	<input type="text" value="24E124127A270222"/>
App EUI	<input type="text" value="24E124C0002A0001"/>
Application Port	<input type="text" value="85"/>
Join Type	<input type="text" value="OTAA"/>
Application Key	<input type="text" value="*****"/>
Spread Factor	<input type="text" value="SF10-DR2"/>
Confirmed Mode	<input type="checkbox"/>
Rejoin Mode	<input checked="" type="checkbox"/>
Set the number of packets sent	<input type="text" value="32"/> packets
ADR Mode	<input checked="" type="checkbox"/>

Parameters	Description
Device EUI	Unique ID of the device which can also be found on the label.
App EUI	Default App EUI is 24E124C0002A0001.
Application Port	The port used for sending and receiving data, default port is 85.
Join Type	OTAA and ABP modes are available.
Application Key	Appkey for OTAA mode, default is 5572404C696E6B4C6F52613230313823.
Device Address	DevAddr for ABP mode, default is the 5 th to 12 th digits of SN.
Network Session	Nwkskey for ABP mode, default is 5572404C696E6B4C6F52613230313823.

Key	
Application Session Key	Appskey for ABP mode, default is 5572404C696E6B4C6F52613230313823.
Spread Factor	If ADR is disabled, the device will send data via this spread factor.
Confirmed Mode	If the device does not receive ACK packet from network server, it will resend data 3 times at most.
Rejoin Mode	Reporting interval \leq 30 mins: device will send specific mounts of LoRaMAC packets to check connection status every 30 mins; If no reply after specific packets, the device will re-join. Reporting interval $>$ 30 mins: device will send specific mounts of LoRaMAC packets every to check connection status every reporting interval; If no reply after specific packets, the device will re-join.
ADR Mode	Allow network server to adjust datarate of the device.
Tx Power	Transmit power of device.

Note:

- 1) Please contact sales for device EUI list if there are many units.
- 2) Please contact sales if you need random App keys before purchase.
- 3) Select OTAA mode if you use Milesight IoT cloud to manage devices.
- 4) Only OTAA mode supports rejoin mode.

LoRaWAN Frequency Settings:

Go to **Setting->LoRaWAN Settings** of ToolBox App to select supported frequency and select channels to send uplinks. Make sure the channels match the LoRaWAN® gateway.

* Support Frequency

AS923 ▼

<input checked="" type="checkbox"/>	-	923.2	+
<input checked="" type="checkbox"/>	-	923.4	+
<input type="checkbox"/>	-	922.2	+
<input type="checkbox"/>	-	922.4	+
<input type="checkbox"/>	-	922.6	+

If frequency is one of CN470/AU915/US915, you can enter the index of the channel that you want to enable in the input box, making them separated by commas.

Examples:

1, 40: Enabling Channel 1 and Channel 40

1-40: Enabling Channel 1 to Channel 40

1-40, 60: Enabling Channel 1 to Channel 40 and Channel 60

All: Enabling all channels

Null: Indicates that all channels are disabled

* Support Frequency

AU915

Enable Channel Index i

0-71

Index	Frequency/MHz i
0 - 15	915.2 - 918.2
16 - 31	918.4 - 921.4
32 - 47	921.6 - 924.6
48 - 63	924.8 - 927.8

Note:

For -868M model, default frequency is EU868;

For -915M model, default frequency is AU915.

3.3 General Settings

Go to **Device->Setting->General Settings** of ToolBox App to change the reporting interval, etc.

Reporting Interval - 1080 + min

LED Indicator i ☐

Change Password ☐

Parameters	Description
Reporting Interval	Reporting interval of magnet, tamper and battery level to network server. Default: 1080mins, Range: 1 - 1080 mins Note: WS301 will also transmit alarm when magnet status is changed or

	tamper button is activated.
LED Indicator	Enable or disable the light indicating in chapter 2.3 . Note: The indicator of reset button is not allowed to disable.
Change Password	Change the password for ToolBox App to write this device.

3.4 LoRa D2D Settings

LoRa D2D protocol is developed by Milesight and used for setting up transmission among Milesight devices without gateway. When the LoRa D2D setting is enabled, WS301 can work as a LoRa D2D controller to send control commands to trigger LoRa D2D agent devices.

1. Enable LoRa D2D feature.
2. Define a unique LoRa D2D key which is the same as LoRa D2D agent devices, then select the frequency and spreading factor. (Default LoRa D2D Key: 5572404C696E6B4C6F52613230313823)

LoRa D2D Settings ^

Enable

LoRa D2D Key

Spread Factor

SF12-DR0 ▼

Frequency/MHz - 9.525 +

3. Enable one of WS301 status and configure a 2-byte hexadecimal command (This command is pre-defined in LoRa D2D agent device). When WS301 detects this status, it will send the control command to corresponding LoRa D2D agent devices.

Note: When this feature is enabled, the device will not send data to LoRaWAN® network server if WS301 magnet status changes.

Sensor Status: Close

Control command

0001

Sensor Status: Open

Control command

ff01

3.5 Maintenance

3.5.1 Upgrade

1. Download firmware from Milesight website to your smartphone.
2. Open Toolbox App and click "Browse" to import firmware and upgrade the device.

Note:

- 1) Operation on ToolBox is not supported during an upgrade.
- 2) Only Android version ToolBox supports the upgrade feature.

Status	Setting	Maintenance
SN		6141B1214129
Model		WS301-915M
Firmware Version		V1.2
Hardware Version		V1.0
Manual Upgrade		
<input type="button" value="Browse"/>		

3.5.2 Backup

WS301 supports configuration backup for easy and quick device configuration in bulk. Backup is allowed only for devices with the same model and LoRa frequency band.

1. Go to "Template" page on the App and save current settings as a template. You can also edit the template file.
2. Select one template file that saved in the smartphone and click "Write", then attach it to another device to write configuration.

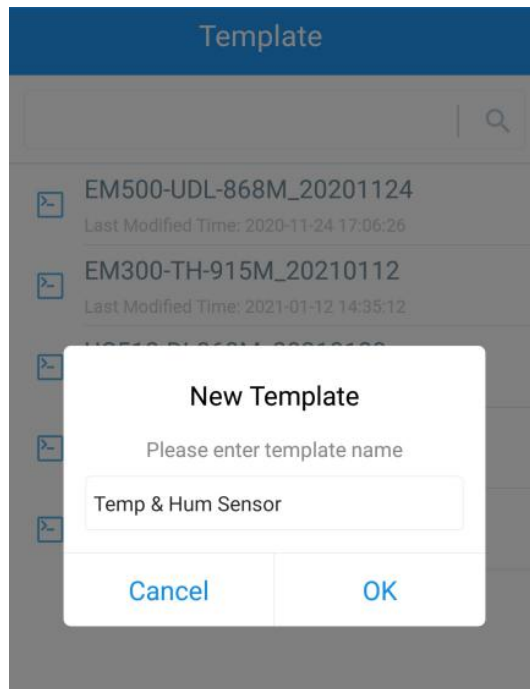

Note: Slide the template item left to edit or delete the template. Click the template to edit the configurations.

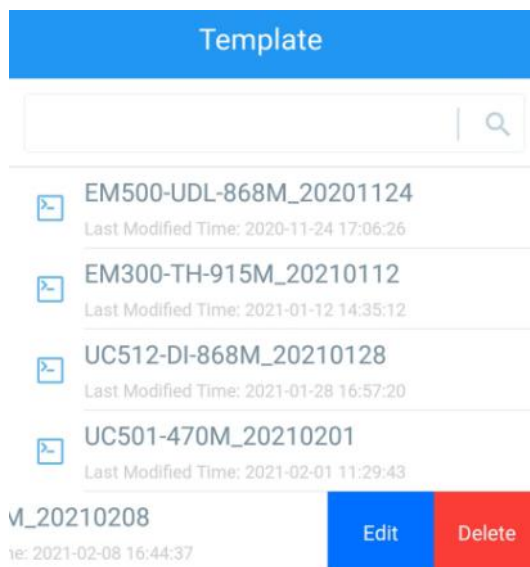

3.5.3 Reset to Factory Default

Please select one of the following methods to reset device:

Via Hardware: Hold on the reset button inside the device for more than 10s. After reset complete, the indicator will blink in green twice and device will reboot.

Via ToolBox App: Go to **Device->Reset** to click "Reset", then attach smartphone with NFC area to device to complete reset.

Status	Setting	Maintenance
SN	6141B1214129	
Model	WS301-915M	
Firmware Version	V1.2	
Hardware Version	V1.0	
Manual Upgrade		
Browse		
Restore Factory Default		
Reset		

4. Installation

3M Tapes Fix:

Tear the 3M tapes of both parts, then make sure the magnet part is placed inside the door (portable part) and sensor is inside the door frame (fixed part). For double doors, put every part on each door.

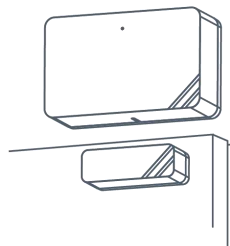

Screw Fix:

Remove the cover of both parts, screw the covers on the mounting positions, then install back the devices.

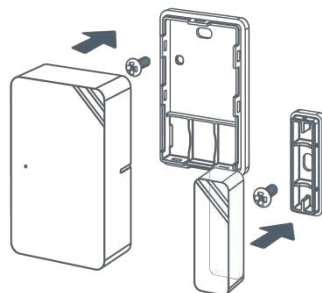

Note:

1. The notch side of magnet should face the notch side of sensor, otherwise it may affect the sensitivity of on/off detection.
2. The plane distance between sensor and magnet should not be more than 15mm, and the height difference should be less than 7.5 mm.

5. Device Payload

All data are based on the following format(HEX):

Channel1	Type1	Data1	Channel2	Type2	Data2	Channel 3	...
1 Byte	1 Byte	N Bytes	1 Byte	1 Byte	M Bytes	1 Byte	...

For decoder examples please find files on <https://github.com/Milesight-IoT/SensorDecoders>.

5.1 Basic Information

WS301 reports basic information of sensor whenever joining the network.

Channel	Type	Description
ff	01(Protocol Version)	01=> V1
	08 (Device SN)	12 digits
	09 (Hardware Version)	01 40 => V1.4
	0a (Software Version)	01 14 => V1.14
	0b (Power On)	Device is on
	0f (Device Type)	00: Class A, 01: Class B, 02: Class C

Example:

ff0bff ff0101 ff086538b2232131 ff090100 ff0a0102 ff0f00					
Channel	Type	Value	Channel	Type	Value
ff	0b (Power On)	ff (Reserved)	ff	01 (Protocol Version)	01 (V1)
Channel	Type	Value	Channel	Type	Value
ff	08(Device SN)	6538b22321 31	ff	09 (Hardware version)	0100 (V1.0)
Channel	Type	Value	Channel	Type	Value
ff	0a (Software version)	0102 (V1.2)	ff	0f (Device Type)	00 (Class A)

5.2 Sensor Data

WS301 reports open/close status and tamper status as follows:

- According to reporting interval;
- When magnet or tamper status has changed.

Channel	Type	Description
01	75(Battery Level)	UINT8, Unit: %
03	00(Magnet Status)	00=>Switch close 01=>Switch open
04	00(Tamper Status)	00=>Device is installed 01=>Device is un-installed

Example:

01 75 64 03 00 00 04 00 01					
Channel	Type	Value	Channel	Type	Value
01	75 (Battery)	64 => 100%	03	00 (Magnet Status)	00 (Close)
Channel	Type	Value			
04	00 (Tamper Status)	01 (Un-installed)			

5.3 Downlink Commands

WS301 supports downlink commands to configure the device. The application port is 85 by default.

Channel	Type	Description
ff	03 (Set Reporting Interval)	2 Bytes, unit: s

Example: Set reporting interval as 20 minutes.

ff03b004		
Channel	Type	Value
ff	03 (Set Reporting Interval)	b0 04 => 04 b0 = 1200s = 20 minutes

-END-

