Wireless 1-Phase Current Meter

Wireless 1-Phase Current Meter R718N1 User Manual



Copyright©Netvox Technology Co., Ltd.

This document contains proprietary technical information which is the property of NETVOX Technology. It shall be maintained in strict confidence and shall not be disclosed to other parties, in whole or in part, without written permission of NETVOX Technology. The specifications are subject to change without prior notice.

Table of Content

| | |
|---|----|
| 1. Introduction | 2 |
| 2. Appearance | 3 |
| 3. Main Features | 3 |
| 4. Set up Instruction..... | 4 |
| 5. Data Report..... | 5 |
| 6. Measuring Range and Accuracy..... | 9 |
| 7. Installation | 10 |
| 8. Information about Battery Passivation..... | 12 |
| 9. Important Maintenance Instruction | 13 |

1. Introduction

R718N1 series equipment is a current detection device of Netvox Class A type equipment based on LoRaWAN open protocol. It measures single-phase current through external current transformer. It is divided into:

R718N1 Wireless 1-Phase Current Meter with 1 x 30A Solid Core CT

R718N13 Wireless 1-Phase Current Meter with 1 x 30A Clamp-On CT

R718N17 Wireless 1-Phase Current Meter with 1 x 75A Clamp-On CT

R718N115 Wireless 1-Phase Current Meter with 1 x 150A Clamp-On CT

R718N125 Wireless 1-Phase Current Meter with 1 x 250A Clamp-On CT

R718N163 Wireless 1-Phase Current Meter with 1 x 630A Clamp-On CT

They are compatible with LoRaWAN protocol.

LoRa Wireless Technology:

LoRa is a wireless communication technology dedicated to long distance and low power consumption. Compared with other communication methods, LoRa spread spectrum modulation method greatly increases to expand the communication distance. Widely used in long-distance, low-data wireless communications. For example, automatic meter reading, building automation equipment, wireless security systems, industrial monitoring. Main features include small size, low power consumption, transmission distance, anti-interference ability and so on.

LoRaWAN:

LoRaWAN uses LoRa technology to define end-to-end standard specifications to ensure interoperability between devices and gateways from different manufacturers.

2. Appearance



R718N1



R718N13

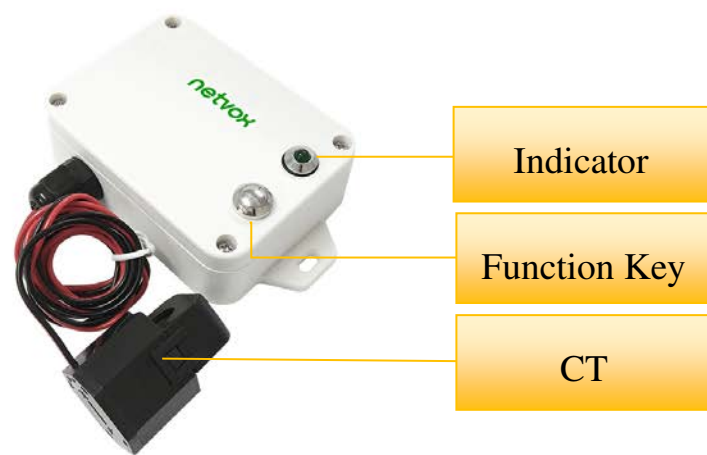

R718N17



R718N115



R718N125



R718N163

3. Main Features

- Compatible with LoRaWAN protocol
- 2 sections ER14505 3.6V Lithium AA battery
- Current detection
- Protection level: Main body-IP53, CT- IP30
- Compatible with LoRaWAN™ Class A
- Frequency hopping spread spectrum technology
- Configuration parameters can be configured through third-party software platforms, data can be read and alarms can be set via SMS text and email (optional)
- Available third-party platform: Actility / ThingPark, TTN, MyDevices/Cayenne
- Low power consumption and long battery life

Note:

Battery life is determined by the sensor reporting frequency and other variables, please refer to

http://www.netvox.com.tw/electric/electric_calc.html

On this website, users can find battery life time for varied models at different configurations.

4.Set up Instruction

On/Off

| | |
|--------------------------------------|---|
| Power on | Insert batteries. (users may need a flat blade screwdriver to open) |
| Turn on | Press and hold the function key for 3 seconds till the green indicator flashes once. |
| Turn off(Restore to factory setting) | Press and hold the function key for 5 seconds till green indicator flashes for 20 times. |
| Power off | Remove Batteries. |
| Note: | <ol style="list-style-type: none"> 1. Remove and insert the battery; the device is at off state by default. 2. On/off interval is suggested to be about 10 seconds to avoid the interference of capacitor inductance and other energy storage components. 3. At 1st -5th second after power on, the device will be in engineering test mode. |

Network Joining

| | |
|--|---|
| Never joined the network | <p>Turn on the device to search the network to join.</p> <p>The green indicator stays on for 5 seconds: success</p> <p>The green indicator remains off: fail</p> |
| Had joined the network (not at factory setting) | <p>Turn on the device to search the previous network to join.</p> <p>The green indicator stays on for 5 seconds: success</p> <p>The green indicator remains off: fail</p> |

Function Key

| | |
|------------------------------|---|
| Press and hold for 5 seconds | <p>Restore to factory setting / Turn off</p> <p>The green indicator flashes for 20 times: success</p> <p>The green indicator remains off: fail</p> |
| Press once | <p>The device is in the network: green indicator flashes once and sends a report</p> <p>The device is not in the network: green indicator remains off</p> |

Sleeping Mode

| | |
|-------------------------------------|--|
| The device is on and in the network | <p>Sleeping period: Min Interval.</p> <p>When the reportchange exceeds setting value or the state changes: send a data report according to Min Interval.</p> |
|-------------------------------------|--|

Low Voltage Warning

| | |
|-------------|------|
| Low Voltage | 3.2V |
|-------------|------|

5. Data Report

The device will immediately send a version packet report along with an uplink packet including current, multiplier and battery voltage.

Default setting:

Maximum time: Max Interval =30 min (1800s)

Minimum time: Min Interval =30 min (1800s) (Check the current voltage once per Min Interval)

CurrentChange:0x0064 (100mA)

Note:

The data transmission period of the device is subject to the programming configuration.

If the minimum time of report configuration is less than 30 seconds, all counted as 30 seconds.

If the maximum time of report configuration is less than minimum time, all counted as minimum time.

The device starts sampling 15 seconds before the minimum time is due and lasts for 15 seconds.

If the current changes frequently, the sampling result may be inaccurate.

Press function key to trigger.

For the analysis of the data reported by the device,

refer to the Netvox LoraWAN Application Command document and <http://www.netvox.com.cn:8888/page/index>.

Data report configuration and sending period are as following:

| Min. Interval (Unit:second) | Max. Interval (Unit:second) | Reportable Change | Current Change \geq Reportable Change | Current Change $<$ Reportable Change |
|--------------------------------|----------------------------------|-------------------|--|---|
| Any number between 30~65535 | Any number between Min.~65535 | Can not be 0. | Report per Min. Interval | Report per Max. Interval |

Example of ReportDataCmd

FPort: 0x06

| | | | | |
|-------|---------|------------|------------|-------------------|
| Bytes | 1 | 1 | 1 | Var(Fix=8 Bytes) |
| | Version | DeviceType | ReportType | NetvoxPayLoadData |

Version– 1 bytes –0x01—the Version of NetvoxLoRaWAN Application Command Version

DeviceType– 1 byte – Device Type of Device

The devicetype is listed in Netvox LoRaWAN Application Devicetype doc

ReportType – 1 byte –the presentation of the NetvoxPayLoadData, according the devicetype

NetvoxPayLoadData– Fixed bytes (Fixed =8bytes)

| Version | Device Type | Report Type | NetvoxPayLoadData | | | |
|---------|-------------|-------------|-------------------------------|------------------------------|---|---------------------------------|
| 0x01 | 0x49 | 0x01 | Battery (1Byte, unit:0.1V) | Current (2Bytes,Unit:1ma) | Multiplier(1Byte), the real current should convert with Current* Multiplier | Reserved (4Bytes,fixed 0x00) |

Uplink: 0149012403E80100000000

1st byte(01): Version

2nd byte(49): DeviceType 0x49 – R718N1 Series

3rd byte(01): ReportType

4th byte(24): Battery – 3.6V, 24 (H_{ex})= 36 (D_{ec}), 36x0.1=3.6 V

5th 6th byte(03E8): Current – 1000mA , 03E8(H_{ex})= 1000 (D_{ec})

7th byte(01): Multiplier – 1

8th ~11th byte(00000000): Reserved

Actual current value = Current* Multiplier, 1000mA*1= 1000mA = 1A

Example of ConfigureCmd

FPort: 0x07

| | | | |
|-------|-------|------------|-------------------|
| Bytes | 1 | 1 | Var(Fix =9 Bytes) |
| | CmdID | DeviceType | NetvoxPayLoadData |

CmdID– 1 bytes

DeviceType– 1 byte – Device Type of Device

NetvoxPayLoadData– var bytes (Max=9bytes)

Report configuration:

| Description | Device | Cmd ID | Device Type | NetvoxPayLoadData | | | |
|----------------------|--------|--------|-------------|---------------------------------|---------------------------------|-----------------------------------|---------------------------------|
| ConfigReport Req | R718N1 | 0x01 | 0x49 | MinTime (2bytes Unit:s) | MaxTime (2bytes Unit:s) | CurrentChange (2byte Unit:1mA) | Reserved (3Bytes,Fixed 0x00) |
| ConfigReport Rsp | | 0x81 | | Status (0x00_success) | Reserved (8Bytes,Fixed 0x00) | | |
| ReadConfig ReportReq | | 0x02 | | Reserved (9Bytes,Fixed 0x00) | | | |
| ReadConfig ReportRsp | | 0x82 | | MinTime (2bytes Unit:s) | MaxTime (2bytes Unit:s) | CurrentChange (2byte Unit:1mA) | Reserved (3Bytes,Fixed 0x00) |

(1) Configure report parameters MinTime = 15min, MaxTime = 15min, CurrentChange = 100mA

Downlink: 0149038403840064000000

The device returns:

8149000000000000000000 (Configuration succeeded)

8149010000000000000000 (Configuration failed)

(2) Read device configuration parameters

Downlink: 0249000000000000000000

The device returns:

8249038403840064000000 (current device configuration parameters)

Example#1 based on MinTime = 1 Hour, MaxTime= 1 Hour, Reportable Change i.e. CurrentChange=100mA

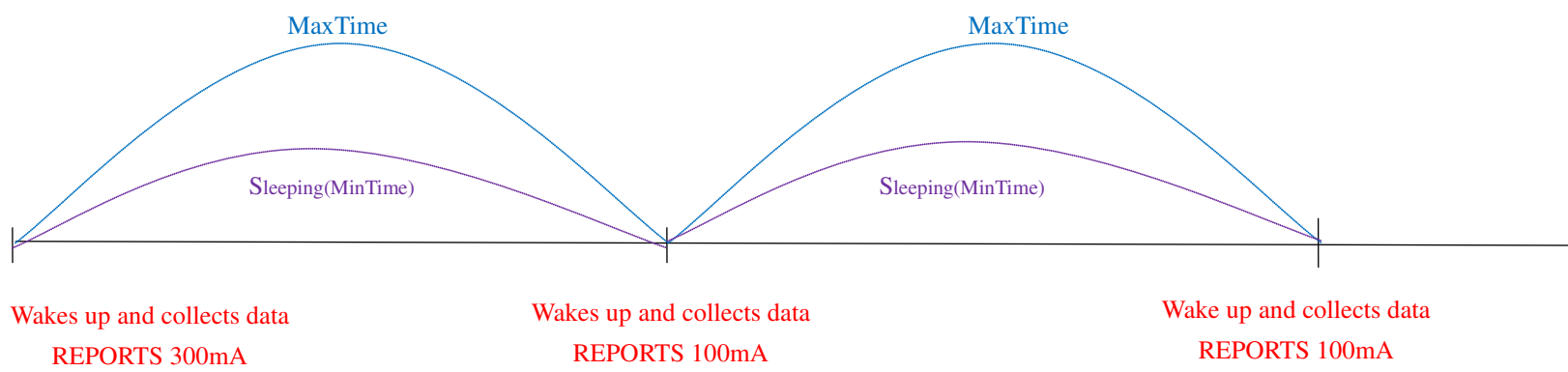

Note: MaxTime=MinTime. Data will only be report according to MaxTime (MinTime) duration regardless CurrentChange value.

Example#2 based on MinTime = 15 Minutes, MaxTime= 1 Hour, Reportable Change i.e. CurrentChange= 100mA.

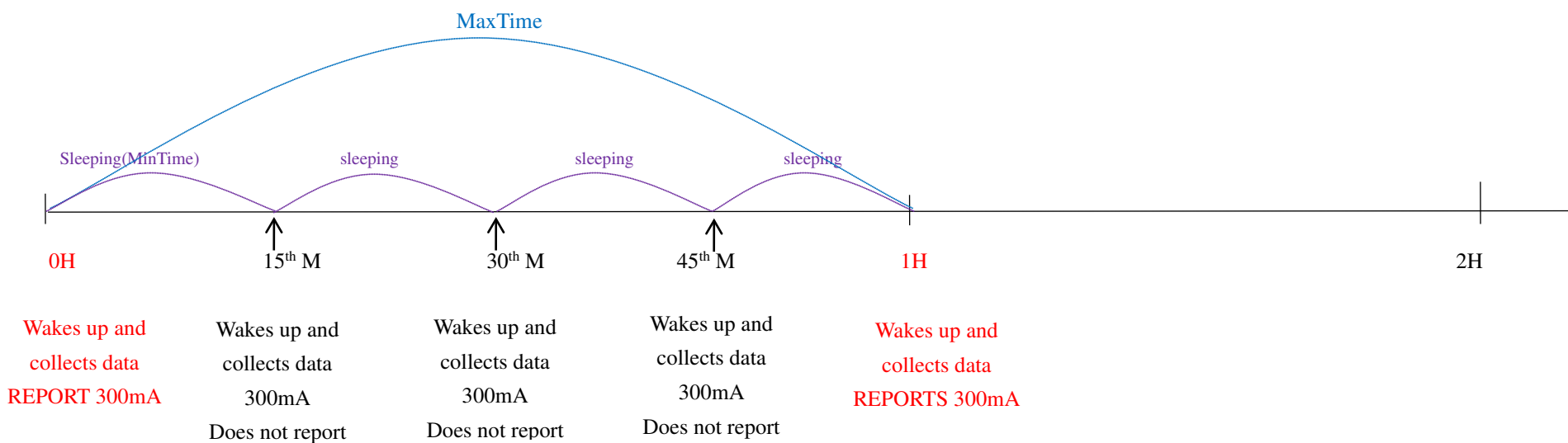

Example#3 based on MinTime = 15 Minutes, MaxTime= 1 Hour, Reportable Change i.e. CurrentChange= 100mA

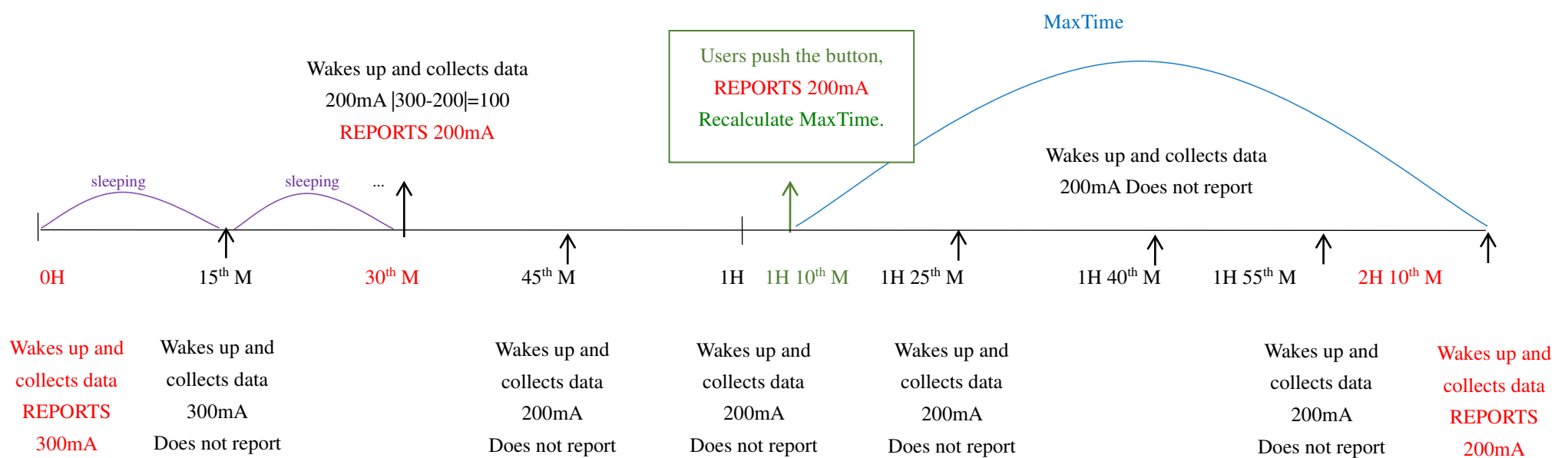

Notes:

- 1) The device only wakes up and performs data sampling according to MinTime Interval. When it is sleeping, it does not collect data.
- 2) The data collected is compared with the last data reported. If the data variation is greater than the ReportableChange value, the device reports according to MinTime interval. If the data variation is not greater than the last data reported, the device reports according to MaxTime interval.
- 3) We do not recommend to set the MinTime Interval value too low. If the MinTime Interval is too low, the device wakes up frequently and the battery will be drained soon.
- 4) Whenever the device sends a report, no matter resulting from data variation, button pushed or MaxTime interval, another cycle of MinTime/MaxTime calculation is started.

6. Measuring Range and Accuracy

R718N1 (solid CT) measurement range is 100mA ~ 30A ($\pm 1\%$)

718R718N13 (Clamp-On CT) Measurement range is 100mA ~ 30A ($\pm 1\%$)

718R718N17 (Clamp-On CT) Measurement range is 100mA ~ 75A ($\pm 1\%$)

718R718N115 (Clamp-On CT) Measurement range is 1A ~ 150A ($\pm 1\%$)

718R718N125 (Clamp-On CT) Measurement range is 1A ~ 250A ($\pm 1\%$)

718R718N163 (Clamp-On CT) The measurement range is 5A ~ 630A ($\pm 1\%$)

Note:

The three large CT current models -- R718N115, R718N125, and R718N163 report 0A when the current is less than 1A, and the others R718N1 models report 0A when the current is less than 0.1A.

7. Installation

This product comes with waterproof function.

When using it, the back of it can be adsorbed on the iron surface, or the two ends can be fixed to the wall with screws.

When installing the current transformer, separate the live and neutral wires, and take out the live wire separately and start the measurement according to the wiring below.

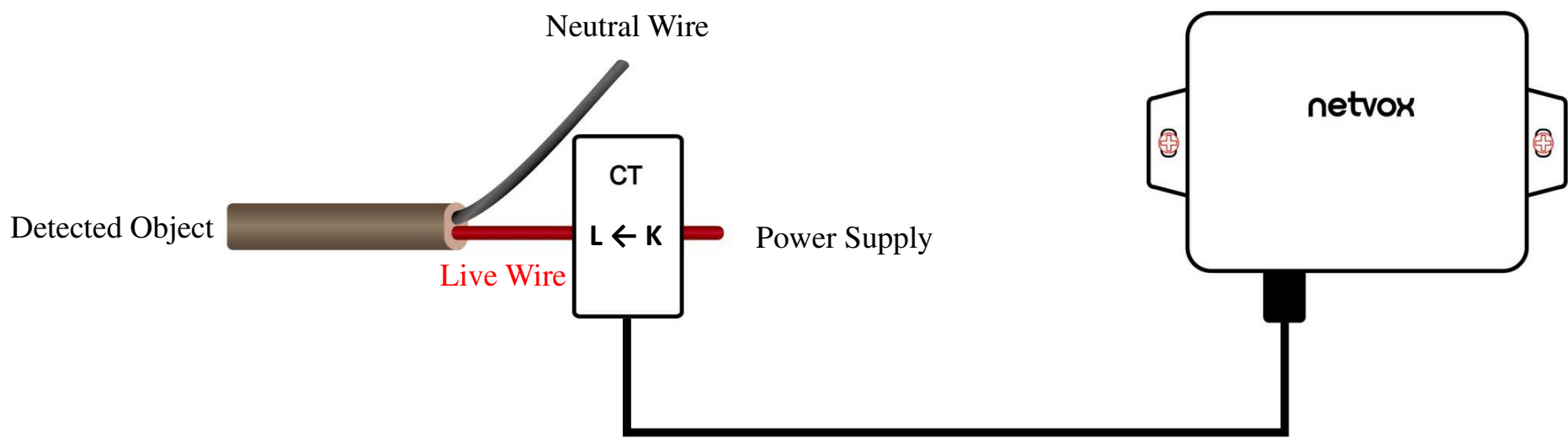

CT Wiring Schematic Diagram (Current direction K→L)

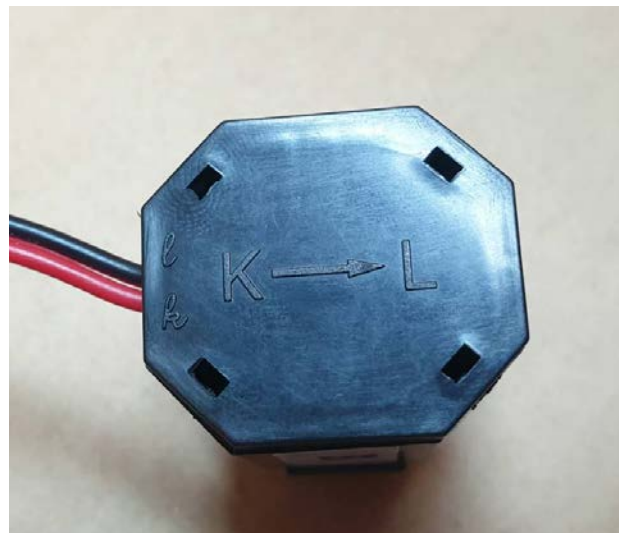

If the live wire and the neutral wire are connected together at the same time, they will offset each other and the measurement is 0.

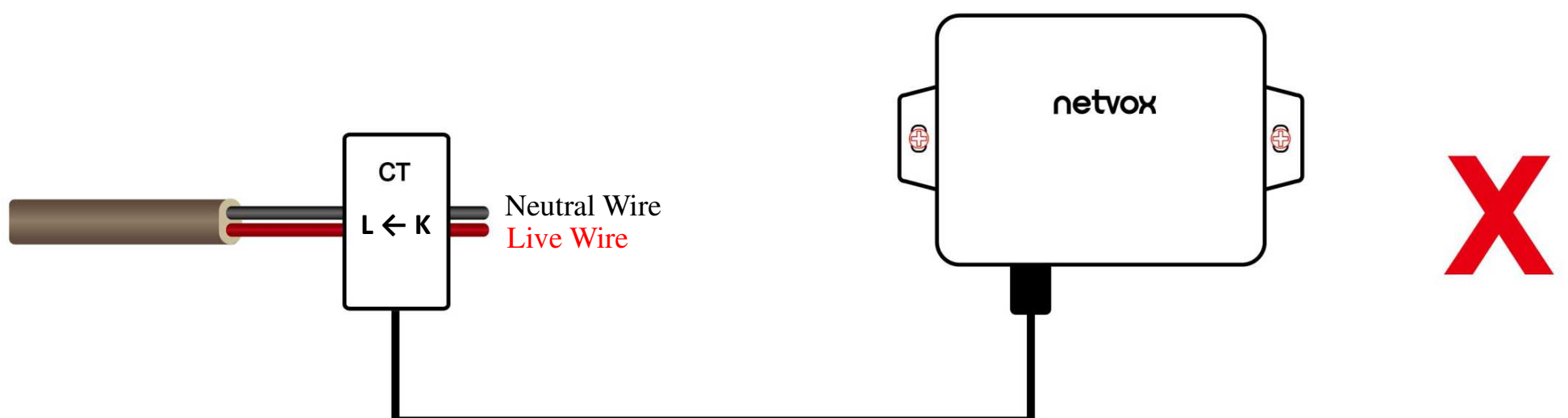

1. The single-phase current detector (R718N1) has a built-in magnet (see Figure 1 below). It can be attached to the surface of an object with iron during installation, which is convenient and quick.

To make the installation more secure, please use screws (purchased separately) to fix the device to the wall or other objects (such as the installation diagram).

Note: Do not install the device in a metal shielded box or in an environment surrounded by other electrical equipment to avoid affecting the wireless transmission of the device.

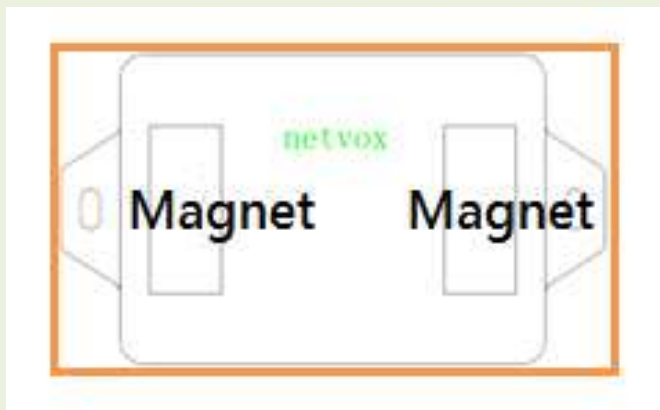

2. Open the clamp-on current transformer, and then pass the live wire through the current transformer according to the installation.

Note:

"L←K" is marked on the bottom of the CT.

3. Precautions:

- Before using, user must check whether the appearance is deformed; otherwise, the test accuracy will be affected.
- The using environment should be kept away from strong magnetic fields, so as not to affect the test accuracy. It is strictly forbidden to use in humid and corrosive gas environments.
- Before installation, please confirm the current value of the load. If the current value of the load is higher than the measurement range, select a model with a higher measurement range.

4. The single-phase current detector (R718N1) takes 15 seconds to sample the current, that is, the device starts sampling 15 minutes before the arrival of MinTime. If the current value of the sample is relatively compared with the current value reported last time, it exceeds the set value (default value 100mA), when the MinTime is reached, the current value of the current sample is immediately reported.

If the current change does not exceed the default value, the data will be reported regularly according to Maxtime.

Short press the [Key] of the device to start sampling data and report the data about 15 seconds after pressing the key.

Note: MinTme cannot be set less than 30 seconds. MaxTime must be set greater than Min Time.

The single-phase current detector (R718N1) is suitable for the following scenarios:

- School
- Factory
- The mall
- Office building
- Smart building

Where the electrical data of the equipment needs to be detected.

Note:

Please do not disassemble the device unless it is required to replace the batteries.

Do not touch the waterproof gasket, LED indicator light, function keys when replacing the batteries. Please use suitable screwdriver to tighten the screws (if using an electric screwdriver, it is recommended to set the torque as 4kgf) to ensure the device is impermeable.

8. Information about Battery Passivation

Many of Netvox devices are powered by 3.6V ER14505 Li-SOCl₂ (lithium-thionyl chloride) batteries that offer many advantages including low self-discharge rate and high energy density.

However, primary lithium batteries like Li-SOCl₂ batteries will form a passivation layer as a reaction between the lithium anode and thionyl chloride if they are in storage for a long time or if the storage temperature is too high. This lithium chloride layer prevents rapid self-discharge caused by continuous reaction between lithium and thionyl chloride, but battery passivation may also lead to voltage delay when the batteries are put into operation, and our devices may not work correctly in this situation.

As a result, please make sure to source batteries from reliable vendors, and the batteries should be produced within the last three months.

If encountering the situation of battery passivation, users can activate the battery to eliminate the battery hysteresis.

***To determine whether a battery requires activation**

Connect a new ER14505 battery to a 68ohm resistor in parallel, and check the voltage of the circuit.

If the voltage is below 3.3V, it means the battery requires activation.

***How to activate the battery**

- 1) Connect a battery to a 68ohm resistor in parallel
- 2) Keep the connection for 6~8 minutes
- 3) The voltage of the circuit should be $\geq 3.3V$

9. Important Maintenance Instruction

Kindly pay attention to the following in order to achieve the best maintenance of the product:

- Keep the device dry. Rain, moisture, or any liquid might contain minerals and thus corrode electronic circuits. If the device gets wet, please dry it completely.
- Do not use or store the device in dusty or dirty environment. It might damage its detachable parts and electronic components.
- Do not store the device under excessive heat condition. High temperature can shorten the life of electronic devices, destroy batteries, and deform or melt some plastic parts.
- Do not store the device in places that are too cold. Otherwise, when the temperature rises to normal temperature, moisture will form inside, which will destroy the board.
- Do not throw, knock or shake the device. Rough handling of equipment can destroy internal circuit boards and delicate structures.
- Do not clean the device with strong chemicals, detergents or strong detergents.
- Do not apply the device with paint. Smudges might block in the device and affect the operation.
- Do not throw the battery into the fire, or the battery will explode. Damaged batteries may also explode.

All of the above applies to your device, battery and accessories.

If any device is not working properly, please take it to the nearest authorized service facility for repair.

