

DIREKTRONIK

MURIDEO®

Fox & Hound 8K Test Kit

MU-FXHD-GEN-8K

HDMI 2.1 40Gbps FRL Audio/Video Generator & Analyzer



INTRODUCTION	3
FOX/GENERATOR FEATURES	3
HOUND/ANALYZER FEATURES	3
WHATS IN THE BOX	4
SPECIFICATIONS	4
AUDIO/VIDEO DISTRIBUTION SYSTEMS - OVERVIEW	5
FRONT PANEL OVERVIEW: FOX /GENERATOR	6
FRONT PANEL OVERVIEW: HOUND/ANALYZER	9
VIDEO GENERATOR: TIMING & RESOLUTION	12
VIDEO GENERATOR: AUTO BUTTON	14
VIDEO GENERATOR: HDCP BUTTON	15
VIDEO GENERATOR: HDCP INDICATOR LED	15
VIDEO GENERATOR: AUDIO BUTTON	16
VIDEO GENERATOR: COLOR BUTTON	16
VIDEO GENERATOR: HDR BUTTON	17
VIDEO GENERATOR: BACK BUTTON	17
BASIC TROUBLESHOOTING - HDMI CABLE TEST	18
TROUBLESHOOTING DISTRIBUTED SYSTEM - HDCP ISSUE	20
BASIC TROUBLESHOOTING A DISTRIBUTION SYSTEM	22
TROUBLESHOOTING DISTRIBUTED SYSTEM - EDID ISSUE	24
REASONS TO COPY AN EDID TO THE ANALYZER	26
COMMON ISSUES DIAGNOSED EASILY WITH THE FOX AND HOUND TROUBLE- SHOOTING KIT	27
TROUBLESHOOTING TIPS	28
WARRANTY AND GETTING HELP	29
OBTAINING THE WARRANTY SERVICE	30
DISCLAIMER OF WARRANTY	31
GETTING HELP	32
LEGAL NOTICES	32

Introduction

This 40Gbps Generator and Analyzer Testing Kit from Murideo was built as the ideal testing unit for all custom and commercial integrators. The Fox & Hound comes with a 40Gbps Generator and 40Gbps Analyzer. These tools allow you to confirm correct bandwidth, HDCP, resolution, timing, HDR metadata and many more options that could cause system hiccups if not treated correctly.

With devices like 8k displays and sources becoming normal for all video distribution systems, tons of new video formats are coming with it. How are you going to test those new signals? That is why we set out to develop a simple, affordable solution to troubleshoot system issues for today's integrator. The 8K Fox & Hound: A/V Testing and Troubleshooting Kit is a product that can produce and analyze the newest and highest resolutions – 8k resolutions and refresh rates up to 120hz at 40Gbps. It's also affordable enough for every integrator to have on any install/service call!

Questions regarding terminology in this manual please refer to the Murideo Support Community for more information.

- [Knowledge Base - Contains Technical Tips, Training Materials, and Articles.](#)
- [Community - Forum based community.](#)
- [Ticket System - Request support via our Ticket System.](#)

Fox/Generator Features

- HDMI 2.1 Support 40Gbps Fixed Rate Link (FRL)
- 8K@60 4:2:0 10-bit Maximum Resolution
- Selectable Color Space
- Auto Detect (read EDID, generate preferred format)
- High Bit Depth – 8, 10, and 12 bit per pixel support
- HDR (High Dynamic Range) Support; HDR10 and HLG
- Selectable HDCP up to 2.3
- Portable - Battery Operated > Rechargeable batteries included make field troubleshooting much easier.
- Optimized Ergonomics – 2" LCD display and simple menu system makes Fox very user friendly.
- Includes audio confidence test tones > to make sure audio is active on the HDMI line

Hound/Analyzer Features

- HDMI 2.1 Support 40Gbps Fixed Rate Link (FRL)
- Test HDMI Cables up to 40Gbps FRL, full TMDS testing
- View up to 40Gbps Video Content and Format Info
- Audio Confidence Tests (2-Channel & Multichannel)
- Read, Write/Save any EDID (x2 savable Presets)
- Selectable HDCP up to 2.3
- Portable - Battery Operated > Rechargeable batteries included make field troubleshooting much easier.
- Optimized Ergonomics – 2" LCD display and simple menu system makes Hound very user friendly.
- HDR (High Dynamic Range) Support

Whats in the Box

- Fox - Generator
- Hound - Analyzer
- Hard Case
- x2 12V 2A Power Supplies
- x2 Micro USB Cables
- x2 HDMI Cables

Specifications

VIDEO:	
HDMI VERSION	HDMI 2.1 (FRL5 40Gbps)
HDCP VERSION	UP TO HDCP 2.3
HDCP ON/OFF	YES
MAXIMUM CLOCK RATE	600 MCSC (594 MHz)
MAXIMUM THROUGHPUT PER CHANNEL	10.0 GBPS (40 GBPS TOTAL)
RESOLUTION TIMINGS	8K: 24Hz, 25Hz, 30Hz, 50Hz, AND 60Hz 4K: 24Hz, 30Hz, AND 60Hz 1080 (HD): 24Hz, 30Hz, 50Hz AND 60Hz 720: 50Hz AND 60Hz VESA: 60Hz AUTO (AUTO READ/OUTPUT BASED ON EDID)
VIDEO ENCODING	RGB, YCbCr
VIDEO SAMPLING MODELS	RGB 4:4:4, YUV 4:4:4, YUV 4:2:2, YUV 4:2:0
COLOR BIT DEPTH	8, 10, 12, AND AUTO EDID READ
AUDIO:	
AUDIO CHANNELS	UP TO 8 (7.1)
AUDIO OUTPUT	2 CH LPCM AND 8CH LPCM
VU METER CHANNELS	UP TO 8 (7.1)
PORTS:	
HDMI	TYPE A
FIRMWARE	MICRO USB
ENVIRONMENTAL:	
OPERATING TEMPRATURE	23 TO 125°F (-5 TO 51°C)
STORAGE TEMPERATURE	-4 TO 140°F (-20 TO 60°C)
HUMIDITY RANGE	5-90% RH (NO CONDENSATION)
POWER:	
POWER (SINGLE UNIT)	7.4V 2600MAH INTERNAL BATTERY OR WALL ADAPTER
POWER CONSUMPTION (TOTAL FOR SINGLE UNIT)	7.5 WATTS MAX
POWER SUPPLY (x2)	INPUT: AC 100-240V ~ 50/60HZ OUTPUT: DC 12V 2A
DIMENSIONS:	
DIMENSIONS (SINGLE UNIT ONLY - HEIGHT/DEPTH/WIDTH)	MM: 30.25 x 78.4 x 135 INCH: 1.19 x 3.09 x 1.19
DIMENSIONS (CASE - HEIGHT/DEPTH/WIDTH)	MM: 127 x 279.4 x 333.5 INCH: 5 x 11 x 13.13
WEIGHT (SINGLE UNIT)	0.58 LBS/0.26 KG
WEIGHT (CASE AND ACCESSORIES)	6 LBS/2.7 KG

*SPECIFICATIONS SUBJECT TO CHANGE WITHOUT NOTICE. MASS & DIMENSIONS ARE APPROXIMATE

Audio/Video Distribution Systems - Overview

All AV Systems are made of basically 3 main components:

- Sources – This is any device that outputs HDMI – Set top boxes, game consoles, computers and more. This is a HDMI Transmitter device. Substitute the generator during system testing – use the analyzer to test the output of any source for the desired timing characteristic.
- Repeaters – This is a combination device that can be connected between one or several sources and sink devices – like an AVR (audio video receiver) or matrix switch. Use both generator and analyzer for troubleshooting the devices and for system troubleshooting.
- Sinks – This is the display or projector – this is an HDMI Receiver device. Substitute the analyzer for sinks during system testing – use the generator to test sinks by injecting a specific timing characteristic expected to pass through distribution system.

It is imperative to know and understand the interactivity of the devices regardless if the system is simple or complex. Understanding the basics of systematic troubleshooting from source to display (and everything in-between) will greatly improve your chances of resolving issues within the system.



In the diagram above you can see the basic components of an A/V system (#1 = source, #2 = distribution system, #3 = sink). Although this is a simple diagram, imagine there are several devices (AVR, Distribution Amplifier aka HDMI splitter, AVR, HDMI Extender, etc) in place of #2 (the distribution system).

Example of a functioning system based on the diagram above:

1. Generator – generates test pattern (SMPTE Bars) at desired video format and HDCP version.
2. DISTRIBUTION SYSTEM - passes the signal (unaltered).
3. Analyzer – receives and displays the test pattern (SMPTE Bars) at desired video format and HDCP version.

FRONT PANEL OVERVIEW: Fox / Generator



3" color LCD Display with Polycarbonate protective covering

HDCP (High Bandwidth Content Protection) LED: On indicates HDCP is being received

Status (Hot Plug Detect) LED: Solid light indicates that hot plug detect is successful



From Top to Bottom (Left to Right)

1. HDCP Indicator LED – Indicates the presence of HDCP
ON - HDCP is enabled (Up to 2.3)
OFF - No HDCP detected
2. Status Indicator - Indicates that a Hot Plug event has occurred and there is a successful connection between the source, sink, and repeaters in the system.
NOTE: [See page\(s\) 12-13 for a full list of all available timing/resolutions from Vesa up to 8k.](#)
3. 8K Button – Choose from a list of 8K timings up to 40 Gbps FRL.
4. 4K Button – Choose from a list of 4K timings up to 18 Gbps.
5. 1080 Button – Choose from a list of High Definition (HD) 1080 timings.
6. 720 Button – Choose from a list of High Definition (HD) 720 timings.
7. Power Button – Press and hold to power the unit on or off.

8. VESA Button - Choose from a list of VESA timings.
9. Auto Button – When pressed the generator will read the EDID from the sink device that it is connected to. It will then output an A/V signal based on the preferred timing in the EDID.
Note: The battery charge level and Firmware versions are also on this page. To view this information press the down navigation Button.
10. HDCP Button – Choose from a list of HDCP versions up to HDCP 2.3.
NOTE: You will not be able to select HDCP 1.4 if using an FRL signal (any format over 18Gbps) as per HDMI 2.1 specifications.



11. Audio Button - Choose from 3 available options including Mute, 2Ch L-PCM, and 8Ch L-PCM. Use these options for Audio Confidence Testing.
12. Color Button – Choose from a list of Color (chroma subsampling) selections. Use this in combination with a timing Button to achieve desired bandwidth for system testing.
13. HDR Button – Choose from 3 available options including OFF, HDR-10, or HLG (Hybrid Log Gamma).
14. Back Button – Use this Button to return to the live preview screen.
15. Up/Down Arrows – If in the live preview screen, use these Buttons to select/change test patterns. If in a menu, use the UP/Down Buttons to change to your desired setting. Once highlighted you will need to press the OK Button to confirm your selection.
16. OK Button – Use this Button to confirm selections while in a menu.

17. A & B Buttons – These are PRESET Buttons. You can save two presets (A or B). These Buttons have two functions.

- To save your current output configuration, press and hold either the A or B Button for 3 seconds. Next you will see a “Save Configuration” screen. You must press the OK Button confirm your selection.
- Quick press either the A or B Button to select your preset that was saved on the previous step. The generator will now output your saved configuration.



18. HDMI OUTPUT – Connect to any sink or repeater input via HDMI cable.

19. USB ISP – Micro USB port used for installing firmware updates if required.

20. Charge Status – Red LED that will illuminate when the device is charging.

NOTE: Contact [Murideo support](#) if the Red LED is blinking while connected to the PSU.

21. DC/12V – 12V DC power port – connect the included power supply to this port to charge the unit’s internal Li-ion Battery.

NOTE: The generator will function the same either connected to external power or running off the internal battery.



FRONT PANEL OVERVIEW: Hound/Analyzer



3" color LCD Display with Polycarbonate protective covering

HDCP (High Bandwidth Content Protection) LED: On indicates HDCP is being received

Status (Hot Plug Detect) LED: Solid light indicates that hot plug detect is successful



From Top to Bottom (Left to Right)

1. VOL + Button – Use this Button to increase the volume of the internal speaker.
NOTE: This speaker will only output L-PCM audio. Any other type of audio signal will sound distorted.
2. EDID Select Button – This Button allows you to select between 5 canned (built-in) or 2 User EDIDs.
NOTE: See page 10 for more details on saving a User EDID to Preset A or B.
3. Re-Sync Button – Press this Button to trigger a hot-plug event without having to physically disconnect/reconnect the HDMI cable.
4. Power Button – Press and hold to power the unit on or off.
5. VOL - Button – Use this Button to decrease the volume of the internal speaker.
NOTE: This speaker will only output L-PCM audio. Any other type of audio signal will sound distorted.
6. Active EDID Button – Use this button to view the EDID you currently have selected on the analyzer from the EDID SELECT menu. This menu contains 6 built in common EDIDs and two slots for USER EDID. Slots 6 and 7 are USER-A and USER-B. These are reserved for EDIDs you have copied from a device.

7. Cable Test Button – Use this Button to access the HDMI Cable test function. See page(s) 18-19 for more details.
8. HDCP Button – Use this Button to access the HDCP menu. There are 4 options.
 - HDCP 2.X + 1.X - If chosen, the analyzer will only accept a signal that is encrypted with either version of HDCP (1.4, 2.2, or 2.3). If there is no HDCP from the source/repeater no image will be show (NO SIGNAL).
 - HDCP 1.X Only - If chosen, the analyzer will only accept a signal that is encrypted with HDCP version 1.X.
 - HDCP 2.X Only - If chosen, the analyzer will only accept a signal that is encrypted with HDCP version 2.X.
 - NO HDCP - If chosen, the analyzer will only accept a signal that has no HDCP (unencrypted).
9. Video Button – Press to see active video material (this will bring you to the home/preview screen).
10. Info Button – When pressed the analyzer will display the signal & timing information of the device under test (source/repeater).

NOTE: The Firmware versions are also on this page. To view this information press the down navigation



Button. [xxIMAGE HERE](#) highlighted down Button/front screen of analyzerxx

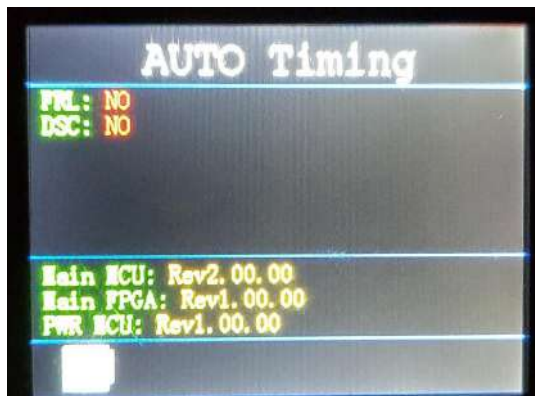

11. Up/Down Buttons – Use these Buttons for navigating and selecting menu items.

NOTE: While in the Live Preview screen these Buttons serve no function.

12. OK Button – Use this Button to confirm selections while in a menu.

13. A/B Buttons – These are PRESET Buttons. You can save two presets (A or B). These Buttons have two functions.

- Press and hold either the A or B Button for 3 seconds while connected to the device that you would like to save the EDID from. Next you will see a "Copy EDID" screen. You must press the OK Button confirm your selection.
 - » You should see the message "Success", this confirms the EDID copied successfully.
 - » If you get "Failure" the EDID did not save. Check connections and verify the device you are connected to is powered on and has an EDID to copy.
- Quick press either the A or B Button to select one of the stored EDIDs.



Note: Top Panel of Analyzer reference items 14-17 below.

14. HDMI INPUT – Connect to any source or repeater output via HDMI cable.

15. USB ISP – Micro USB port used for installing firmware updates if required.

16. Charge Status – Red LED that will illuminate when the device is charging.

NOTE: Contact [Murideo support](#) if the Red LED is blinking while connected to the PSU.

17. DC/12V – 12V DC power port – connect included power supply to this port to charge the unit's internal Li-ion Battery.

NOTE: The analyzer will function the same either connect to external power or running off the internal battery.

Video Generator: Timing & Resolution

Available 8K resolutions

- 1 - 7680x4320 60Hz
- 2 - 7680x4320 50Hz
- 3 - 7680x4320 30Hz
- 4 - 7680x4320 25Hz
- 5 - 7680x4320 24Hz



Available 4K resolutions

- 1 - 3840x2160 60Hz
- 2 - 3840x2160 30Hz
- 3 - 3840x2160 24Hz
- 4 - 4096x2160 60Hz
- 5 - 4096x2160 30Hz
- 6 - 4096x2160 24Hz



Available 1080 resolutions

- 1 - 1080p 60Hz
- 2 - 1080p 50Hz
- 3 - 1080p 30Hz
- 4 - 1080p 24Hz
- 5 - 1080i 60Hz
- 6 - 1080i 50Hz



Available 720 resolutions

- 1 - 720p 60Hz
- 2 - 720p 50Hz



Available VESA resolutions

- 1 - 640x480 60Hz
- 2 - 800x600 60Hz
- 3 - 1024x768 60Hz
- 4 - 1280x1024 60Hz
- 5 - 1366x768 60Hz
- 6 - 1400x1050 60Hz
- 7 - 1440x900 60Hz
- 8 - 1600x900 60Hz
- 9 - 1600x1200 60Hz
- 10 - 1680x1050 60Hz
- 11 - 1920x1200 60Hz



Video Generator: AUTO Button

The AUTO Button will read the EDID from the device that it is connected to. It will then output an audio video signal based on the preferred timing in that EDID.

Note: Depending on the EDID information listed, you may need to press the Down Button to view the rest of the EDID. There may be more than one page of EDID information. Be sure to press the down Button to ensure you see all the available information (see example images below).

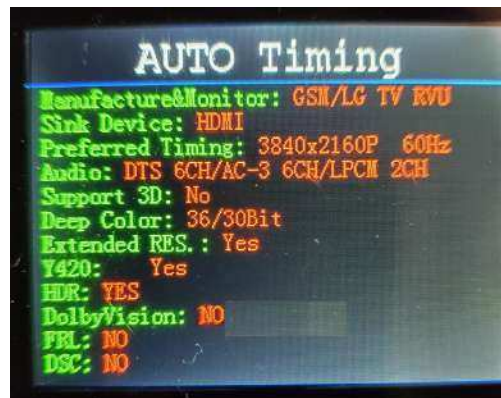

UPDATE #2/3 images with BETTER pics

NOTE: The battery charge level and Firmware versions are also in this menu. To view this information press the down navigation Button.

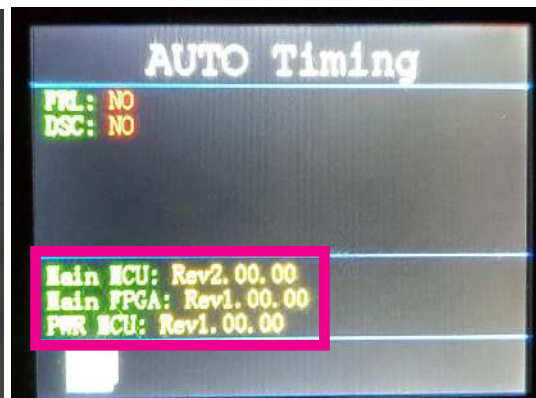
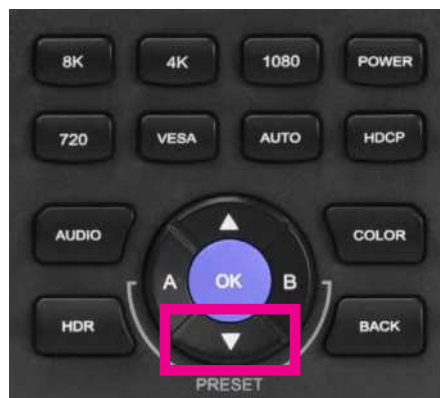

UPDATE #2 image with BETTER pic.

Video Generator: HDCP Button

The HDCP Button will bring up the available HDCP options. There are three options to choose from.

- HDCP Off
- HDCP 2.2
- HDCP 1.4

NOTE: You will not be able to select HDCP 1.4 if using an FRL signal (any format over 18Gbps) as per HDMI 2.1 specifications no FRL Signal can be encrypted using HDCP 1.4.



Video Generator: HDCP Indicator LED

The HDCP LED will indicate the presence of HDCP. The LED has 3 states.

- ON - HDCP is enabled (1.4 or 2.2)
- OFF - No HDCP detected
- Flashing - This may indicate (along with no image) an HDCP compatibility issue.



Video Generator: AUDIO Button

The AUDIO Button will bring up the AUDIO CHANNELS menu. There are three options to choose from for audio output.

- Mute - This will turn off the Audio output of the generator.
- 2CH - This will output a 2CH L-PCM (FL/FR) audio signal.
- 8Ch - This will output a 8CH L-PCM (RRC/RCL/RR/RL/FC/LFE/RF/FL) audio signal.



Video Generator: COLOR Button

The COLOR Button will bring up the COLOR menu. There are ten options to choose from.

- RGB (Full) /8Bit
- RGB (Full) /10Bit
- RGB (Full) /12Bit
- YC420 /8Bit
- YC420 /10Bit
- YC420 /12Bit
- YC422 /8Bit
- YC444 /8Bit
- YC444 /10Bit
- YC444 /12Bit



NOTE: The Generator will not allow you to select a color space if that option exceeds the bandwidth. For example if you select 8K 60Hz for Timing you will only be able to select YC420 /8Bit or YC420 /10Bit.

Video Generator: HDR Button

The HDR Button will bring up the HDR menu. There are three options.

- HDR Off - The generator will output an SDR (Standard Dynamic Range) Signal.
- HDR10 - The generator will output a video signal that includes HDR10 metadata.
- HLG - The generator will output a video signal that is encoded as HLG.



Video Generator: BACK Button

If the front screen of the generator is off (60 seconds of inactivity) you can press the BACK Button to illuminate the screen again to see the current pattern and output timing.

If you are in a menu the BACK Button will return the generator to the live preview screen.

NOTE: The LCD screen will turn off after 60 seconds of inactivity (no button presses). This is normal operation designed to conserve battery life. Press the BACK Button to wake the screen up.

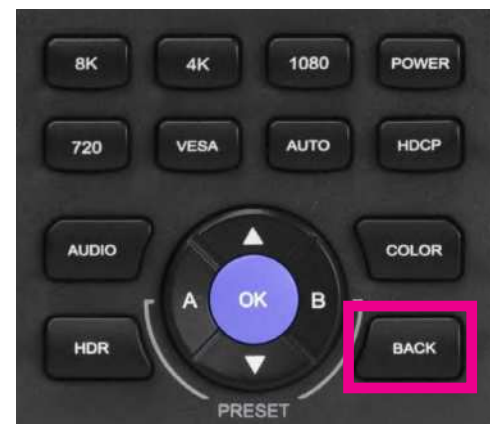

Basic Troubleshooting - HDMI Cable Test

Not all cables are created equal. Older cables may not meet the bandwidth requirements to pass an 8K HDMI 2.1 signal at 40Gbps. You can use the CABLE TEST function to quickly see what that cables maximum bandwidth/capabilities are.



1. Connect the generator to the analyzer using the HDMI cable you would like to test.
2. On the analyzer press the CABLE TEST button. You will now be able to select from 8 different signals at varying bandwidths.

1. FRL 4L10G (40G)	5. 2160p 30 (9G)
2. FRL 4L8G (32G)	6. 1080p 60 (4.5G)
3. 2160p 60 (18G)	7. 720p 60 (2.2G)
4. 2160p 24 (14G)	8. 480p 60 (1G)
3. Choose the bandwidth you would like to test by using the UP/DOWN arrow buttons to highlight.
4. Press the OK button to start. The test will take approximately 15 seconds to complete.



Example of an FRL Signal

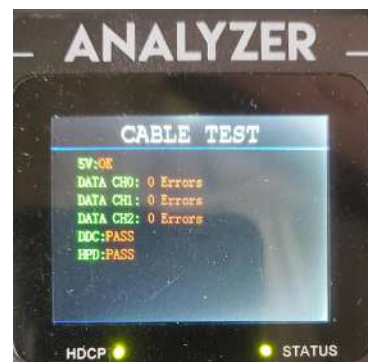

Example of an TMDS



Example of an FRL Signal

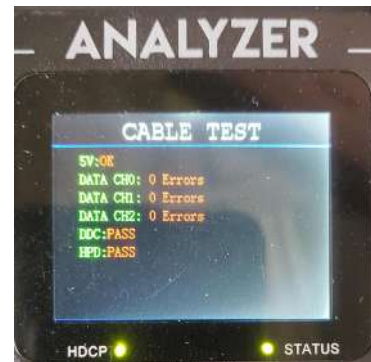

Example of an TMDS Signal

FRL Signal Cable Test

5V: Checks for the presence of 5 Volts on pin 18 of the HDMI cable. There are two possible results.

- OK - 5V is present and the HDMI test will continue.
- FAIL - No 5V is detected and the rest of the test will fail.

DATA CH: This will show the total number of Errors detected in the Audio Video data channels. Ideally the test result should be zero (0) errors. The test is looking for any differences between the pixels of a static image sent from the generator to the analyzer. Errors may not be noticeable when viewing content, but if any errors are detected you may consider replacing that cable.

NOTE: If you install an HDMI cable that shows errors on the Data Channel we cannot guarantee that the cable will work or perform as intended.

DDC (Display Data Channel): This test will verify that essential HDMI protocol signals such as EDID or HDCP are present. There are two possible results.

- OK
- FAIL - Recommend replacing the HDMI cable.

HPD (Hot Plug Detect): This test will check for communications over the HDMI cable on pin 19 between the generator and analyzer. There are two possible results.

- OK
- FAIL - Recommend replacing the HDMI cable.

Troubleshooting Distributed System - HDCP Issue

When it comes to diagnosing an Audio Video distribution system, keep in mind that there are multiple ways to use the Fox & Hound to track down a problem. Refer to the image below for steps 1 through 13 where we will cover one of the processes you can use to troubleshoot a simple distributed system with an HDCP compatibility issue.

NOTE: Notice the green and purple boxes in this troubleshooting diagram below. The purple box indicate where to put the analyzer. The green boxes indicate where to put the generator.

1. Connect the generator to an input on the AVR in place of the source.

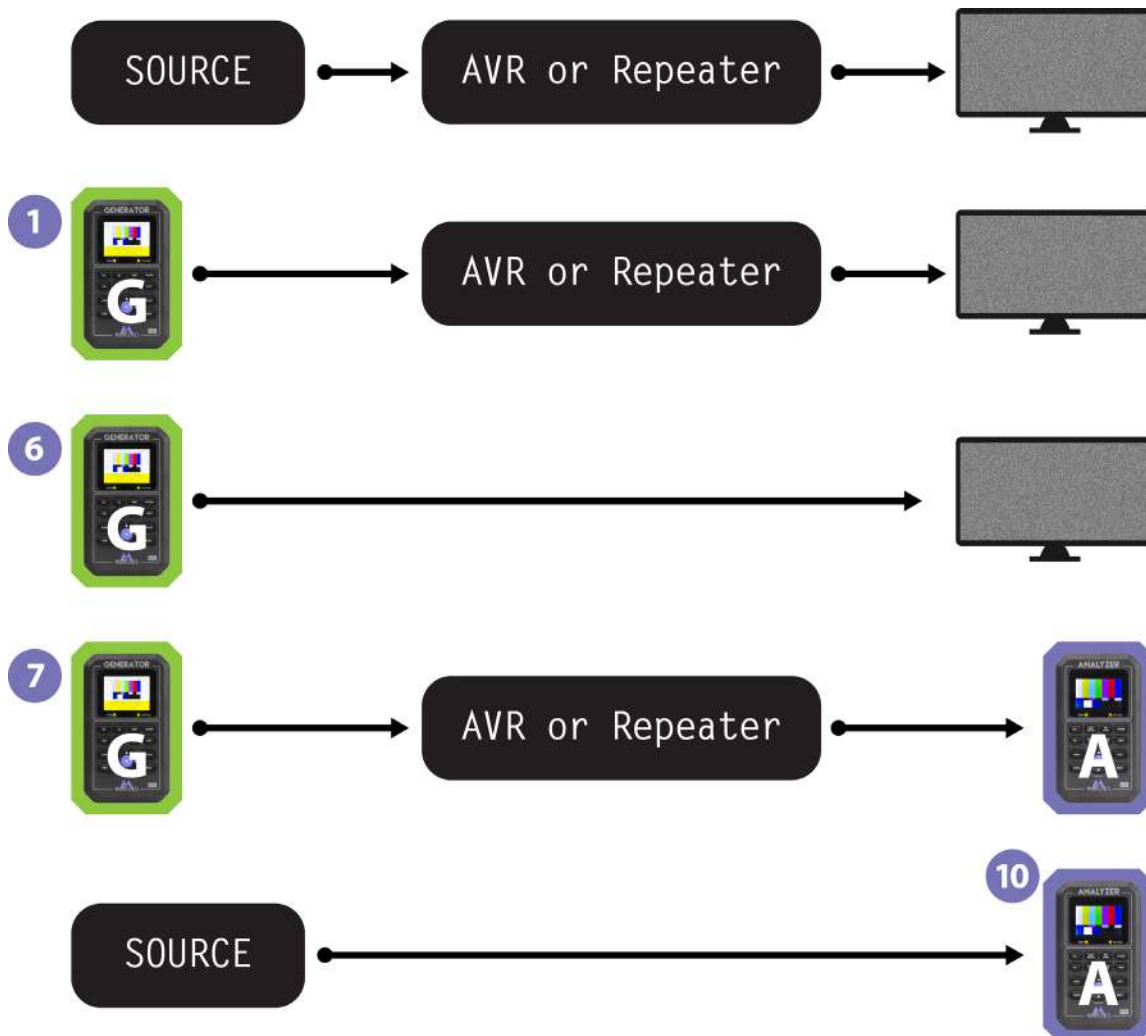

2. Set the generator to output a 1080P signal by pressing the 1080P button and selecting the first option.

NOTE: We are using a 1080P signal to start as most equipment today will be capable of handling this format. If you are testing an older system that is less capable, adjust your generator accordingly. If 1080P does not pass, lower the resolution until you see the test pattern on the sink (TV/Projector).

3. Press the HDCP button on the generator and select HDCP OFF to start.
4. If you see the image (no snow), press the HDCP button on the generator and select HDCP1.4.
5. If you see the image (no snow), press the HDCP button on the generator and select HDCP2.2.
 - If you see the image (no snow), you now know that the repeater and sink (AVR and TV/Projector) are HDCP2.2 compliant.
 - If you see snow on the sink (TV/Projector) with the generator set to HDCP2.2, either the AVR or the sink device is NOT HDCP2.2 compliant.
6. If your results still show snow on the sink (TV/Projector) we need to determine if the issue is with the repeater (AVR) or sink (TV/Projector).
 - Connect the generator directly to the TV (bypassing the AVR), then press the HDCP button and select HDCP1.4. If you see the image (no snow) press the HDCP button, then select HDCP2.2. If you see an image (no snow) you know the TV (and the HDMI port you are connected to) are HDCP2.2 compliant. Based on testing so far the only other device in question is the AVR (repeater). Verify this in the next step.
7. Connect the generator directly to the AVR, then connect the analyzer to the output of the AVR.
8. Select HDCP2.2 on the generator.
9. On the analyzer press the HDCP button and select the first option HDCP2.X+1.X (this selection will also work with NO HDCP).
 - If you see the image (no snow) you have now verified that the AVR (repeater) is HDCP2.2 compliant and is not the issue. Continue to step 10 to test the source.
 - If you see an image with snow you have now verified that the AVR (repeater) is NOT HDCP2.2 compliant and is only capable of HDCP1.4. Now you have verified the AVR (repeater) is causing the issue you will either have to bypass or replace it.
10. Connect the analyzer to the output of the source.
11. Power on the source and wait for it to fully boot up.
12. Press the INFO button on the analyzer.
13. If the analyzer shows HDCP1.4, you know that the source is not HDCP2.2 compliant. In order to have a functional system the source must be replaced/upgraded to a source that is HDCP2.2 compliant.

Basic Troubleshooting of a Distribution System

When it comes to diagnosing an Audio Video distribution system, keep in mind that there are multiple ways to use the Fox & Hound to track down a problem. Refer to the image below for steps 1 through 10 where we will cover one of the processes you can use to troubleshoot a distributed system.

Notice the green and purple boxes in this troubleshooting diagram below. The purple box indicate where you can put an analyzer to see what is coming out. The green boxes indicate where you can put a generator to try to put a signal through the system

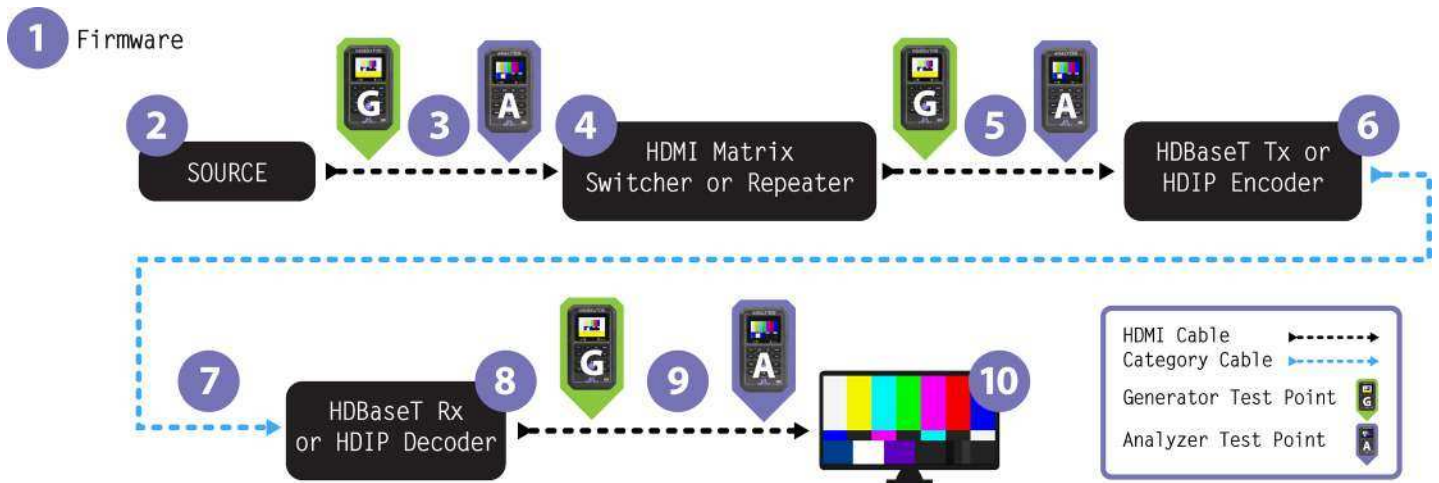

1. Are all devices in the system capable of passing the required bandwidth/signal? Is firmware updated on all devices? Some devices, even if they are brand new, may not be fully up to spec.
NOTE: It is ALWAYS recommended to update to the latest Firmware on each device.
2. Is the source powered on? Is the source functional? Is the HDMI cable properly seated?
3. Is the HDMI cable too short or too long? If the HDMI Cable is directional, is it installed in the right direction (see example image to the right)?

NOTE: The minimum length for an HDMI cable per HDMI Specifications is 2 meters. Short "jump" cables (example 1 foot) may experience sync/display issues. It is recommended to try a longer cable (2 meter minimum) if you are having issues and the HDMI cable passes the cable test.



4. Is the switch powered up? Are the HDMI cables properly seated? Are the HDMI cables routed properly? Are you managing EDID here? Can you send out a test pattern?
5. Is the HDMI cable too short or too long? Did it pass a cable test? If it is directional, is it pointing in the right direction?
6. Is the HDMI connection to the HDBaseT Transmitter properly seated? Does the HDBaseT Transmitter have power? Are you powering the Transmitter or Receiver? Have you checked the status lights (if applicable)? Does the HDBaseT Extender support EDID management? If so, is the EDID set correctly based on the systems needs?

7. Is the CAT cable the correct length? Are you using CAT6 or better (HDBaseT and Murideo recommends solid core CAT6a at the minimum)? Is the cable damaged or twisted? Did you terminate the cable yourself? Did you use a passthrough style connector (where the wires cut at the same time the end is crimped)? Exposed wires can cause Alien Cross Talk resulting in intermittent or no signal passing at all.



8. Is the HDMI connection to the HDBaseT Receiver properly seated? Does the HDBaseT Receiver have power? Are you powering the Transmitter or Receiver? Have you checked the status lights (if applicable)? Does the HDBaseT Extender support EDID management? If so, is the EDID set correctly based on the systems needs?

9. Is the HDMI cable too short or too long? Did it pass a cable test? If it is directional, is it pointing in the right direction?

10. Is the Display powered on? Are you using the correct HDMI input on the display? Some HDMI ports are labeled with their capabilities. The display may be an 8K display, but that does not mean that all available HDMI ports on the display are.

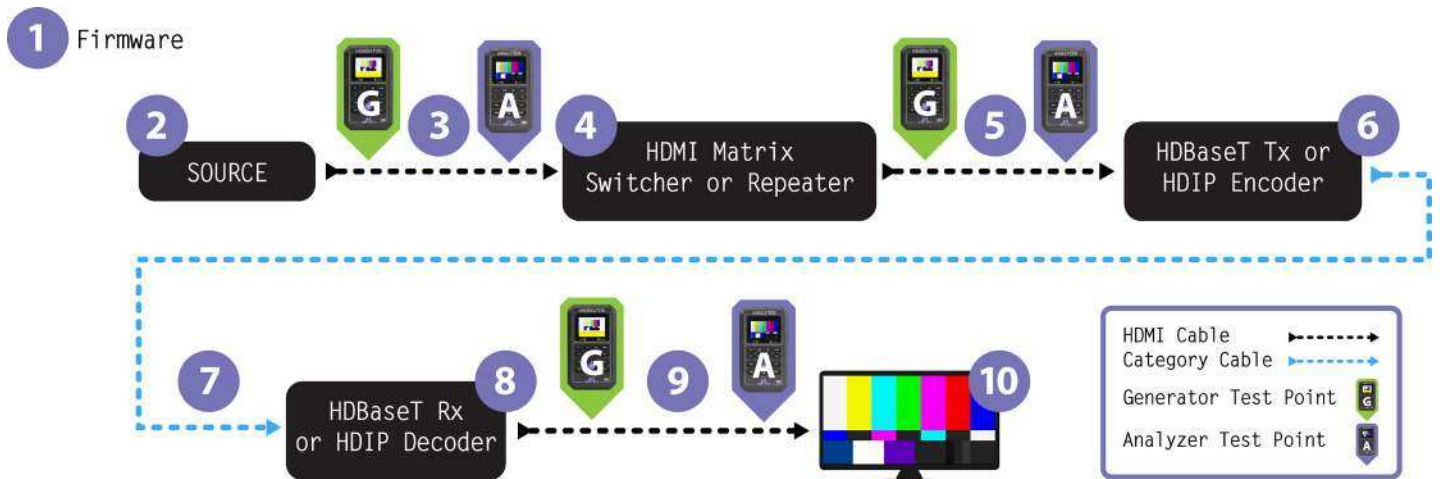

Troubleshooting Distributed System - EDID Issue

When it comes to diagnosing an Audio Video distribution system, keep in mind that there are multiple ways to use the Fox & Hound to track down a problem. Refer to the image below for steps 1-11 where we will cover the steps to diagnose the symptom of no Dolby Vision at the display (even though all devices in the system are capable).

Notice the green and purple boxes in this troubleshooting diagram below. The purple box indicates where you can put an analyzer to view the A/V signal information. The green boxes indicate where you can put a generator to try to put a signal through the system.

1. Connect the generator to an input on the AVR (in place of the source).

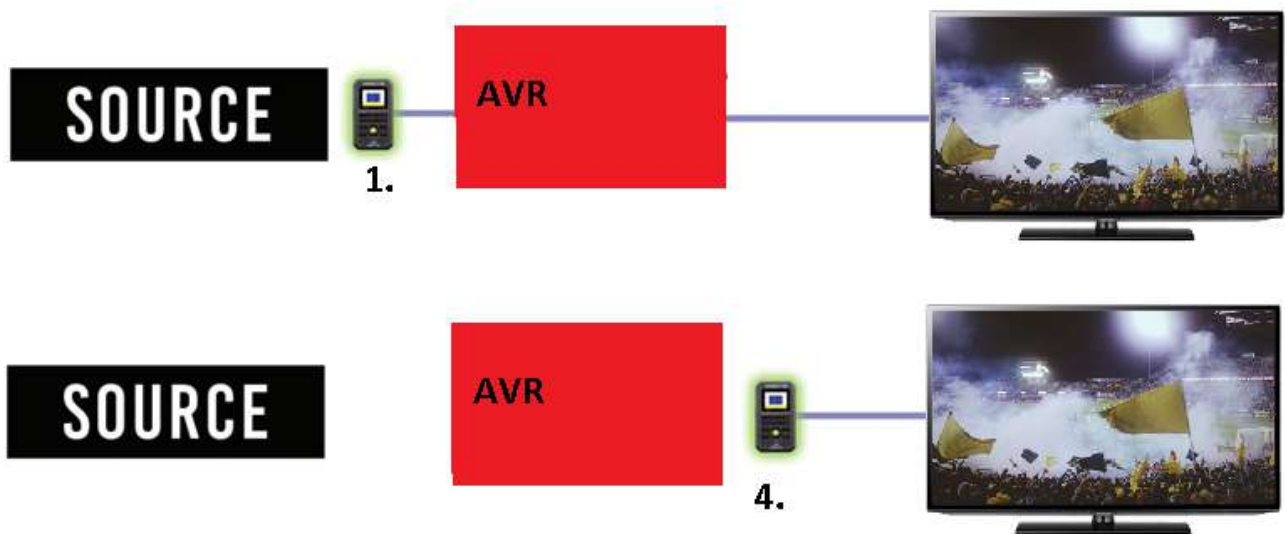

2. AUTO Button - Use this button to view the current EDID information.

NOTE: There may be more EDID information than what is displayed when you press the AUTO button. Press the down button to view any additional EDID information.



3. Notate the EDID information. In the example above you will see that the EDID shows HDR capable (YES), but not Dolby Vision capable (NO). This means that the source will not output Dolby Vision even though it is capable.
4. Connect the generator directly to the sink (TV/Projector) bypassing the repeater (AVR).
5. Press the AUTO button to view the current EDID information.

NOTE: There may be more EDID information than what is displayed when you press the AUTO button. Press the down button to view any additional EDID information.

6. Compare the EDID information you gathered from step 3 to the EDID information that is currently displayed. In the example on the next page you will see the sink (TV/Projector) is showing HDR capable but not Dolby Vision capable.
7. Investigate why the sink's (TV/Projector) EDID states that it is not Dolby Vision capable even though the manufacturer advertises that it is capable.
 - Verify with the manufacturer that it is Dolby Vision capable.
 - CHECK FIRMWARE!!!! Although advertised, some of the display's features may not be available "out of the box". These features can be added later with a Firmware Update. If the firmware is not up to date, install the new firmware then repeat steps 5-6 to confirm that Dolby Vision is now present in the EDID.
 - Verify the HDMI input you are using is capable. It is generally recommended to use the HDMI input that has the highest capabilities (these are usually labeled). Please refer to manufacturers documentation to verify.
 - In some cases you must enable the HDMI input for high bandwidth signals.
8. Repeat steps 4 and 5 to verify Dolby Vision is present in the EDID of the sink (TV/Projector).
9. Repeat steps 1 and 2 to verify Dolby Vision is present in the EDID of both the repeater (AVR) and sink (TV/Projector).
10. Reassemble the system as if it is being used under normal operation.
11. Test by playing Dolby Vision content.

NOTE: It may be necessary to power cycle the entire system after step 10. This is also a recommended final step when troubleshooting.

Reasons to copy an EDID to the analyzer

The analyzer has the ability to copy and save an EDID from any repeater or sink (you can copy and save up to two at a time). This is helpful when troubleshooting a system in many situations that are common but not limited to the following examples:

- Troubleshooting a source and/or a repeater that is not in the same room as the sink.
- Troubleshooting a system where the sink cannot be physically accessed.

NOTE: See [page 12 step #13 "A & B Buttons"](#) on how to copy/save an EDID to the analyzer.

By copying the EDID you now have a portable version of the display that you can carry around the jobsite for easy setup and/or troubleshooting.

Common Issues Diagnosed Easily with the Fox and Hound Troubleshooting Kit

Sparkles - Sparkles are a telltale sign of insufficient cables (for example cables that cannot pass the required bandwidth). Using both the generator and analyzer test **EVERY** HDMI cable in the system for functionality and capability. Verify that **EVERY** cable can pass the required bandwidth for the system to function properly.

No picture/Flashing picture - No picture or flashing picture is usually either a bandwidth limitation or an HDCP compatibility issue. It is recommended when testing bandwidth to turn HDCP off on the generator. Using the generator in place of the source, inject a video signal into the system. Move the generator downstream in place of each device until you pinpoint which device is not passing the signal. If you have verified that signal is passing through the system with HDCP off, the problem is most likely an HDCP compatibility issue. Repeat the process of moving the generator downstream in place of each device (up to HDCP 2.3) until you pinpoint which device is not passing the signal. If you have verified that the signal is passing through the system with HDCP on, connect the analyzer directly to the source and verify functionality, bandwidth, and HDCP Version.

No HDR - Using the analyzer in place of the sink (TV/Projector) verify that HDR is coming through the system from the source all the way to the sink (TV/Projector). Once the system is verified connect the generator directly to the sink (TV/Projector) and press the AUTO button to read the EDID of the sink (TV/Projector). The EDID information will contain whether the sink (TV/Projector) is HDR capable or not. If it is capable of HDR, use the generator in place of the source and inject a video signal that includes HDR metadata into the system. If there is still no HDR at the sink (TV/Projector) move the generator downstream in place of each device until you find out which device is not passing HDR.

Image has banding - Image banding is generally associated with a low bandwidth signal. Using the analyzer in place of the display press the INFO button and note the "Color Depth", then remove the analyzer and reconnect the sink (TV/Projector) to the system. Using the generator in place of the source, inject a video signal of varying bit depths (8, 10, and 12bit). The color bit depth of the signal coming out of the generator should match the color bit depth that you previously noted with the analyzer. If it does not, move the generator downstream in place of each device trying each bit depth until the image no longer has banding issues. Once you discover which device in the system is causing the bandwidth limitation check the output settings of that device and adjust the bit depth accordingly ([Refer to the owner's manual for specific instructions on how to adjust the output of that device](#)).

Discolored video - Discolored video is generally associated with a color space mismatch. Using the analyzer in place of the display press the INFO button to view the signal info and verify whether the colorspace is RGB or YCbCr (YCbCr, YUV, YCC, and YC are all interchangeable). If there is a mismatch in color space between the source and the sink you may see the image but the

image is discolored (typically green or purple). Using the generator in place of the source, inject a video signal into the system (it is recommended to use the SMPTE bar test pattern). Switch between RGB and YCbCr and verify that the image is no longer discolored. If it is still discolored, move the generator downstream from device to device until you find the device that is unnecessarily converting the color space.

Troubleshooting tips

- Simplify troubleshooting. Test one device/cable at a time and take notes.
- Test all HDMI cables for functionality/capability before installation. Just one defective or insufficient HDMI cable can bring down the entire system.
- If using short HDMI cables it is recommended to try a longer cable. The minimum length for an HDMI cable per HDMI Specifications is 2 meters. If you are using short cables (.5m, 1m) it is recommended to try a longer cable (2 meter minimum) as the short cables may cause sync/signal issues.
- Traditional copper based HDMI cables can be unreliable if longer than 4 meters (depending on the build quality). The simple solution would be to use shorter copper based HDMI cables, but if that is not possible you should consider using Active HDMI cables, AOC (Active Optical Cable), or an HDMI extender.
- If using an HDBaseT extender do NOT use pass through style RJ45 connectors when terminating the category cable. These style connectors can cause alien crosstalk and may cause intermittent issues or a complete system failure. When testing category cable avoid using a standard continuity tester as a continuity test is only verifying that the wires are paired correctly. It does NOT test the cable's capability of passing a high frequency video signal, audio, power, Ethernet, or control signals. For certifying HDBaseT cabling we recommend using the MStest Pro. This piece of test equipment will help verify the Category cable length and capability. The cable may be longer than what the HDBaseT extender is capable of (refer to manufacturer's specifications for maximum transmission distance).

Note: HDBaseT is designed to have a point to point connection without any breaks (patch cords, punch-downs, splices, coupler, etc) in the category cable/signal path between the transmitter and receiver. Any breaks in the cable WILL CAUSE ISSUES.

Warranty and Getting Help

AVPro Global Holdings (DBA MURIDEO) offers a 2 year international limited warranty for its Murideo products. Any product first sold to you is guaranteed to be free from defects in both components and workmanship under regular uses. The warranty period commences on the date the item ships. Attention: Your invoice with the date of purchase, model number and serial number of the product is your proof of the date of purchase. The International Limited Warranty is applicable and shall be honored in every country where MURIDEO or its Authorized Service Providers offer warranty service subject to the terms and conditions provided in this International Limited Warranty Statement. Products included in this warranty:

- Murideo SEVEN Series Generators
- Murideo SIX Series Generators
- Murideo SIX Series Analyzers
- Murideo Fox & Hound Series
- Murideo HDMI Test Monitor Series

During the warranty period, the defective hardware of Murideo products will be either repaired or replaced, with new or like new products, at the discretion of Murideo. This International Limited Warranty covers the costs of service parts and labor required to restore your product to fully functional condition. MURIDEO will, at its discretion, repair or replace any defective products or parts thereof covered by this International Limited warranty with refurbished parts of the product that are equivalent to new or like new products in both functionality and performance. A product or part that is repaired or replaced under this International Limited Warranty shall be covered for the remainder of the original warranty period applying to the product or part, or for 90-days, whichever expires last. All exchanged parts and products under this International Limited Warranty will become the property of MURIDEO.

Obtaining the Warranty Service

Warranty service or Returned Merchandise Authorization (RMA) under this International Limited Warranty will be honored only if claims are made within the warranty period. For notifications to MURIDEO or products outside the warranty period, the process will be the same, but charges may apply. Contact details may be obtained on MURIDEO website <https://www.murideo.com/>

Customers are requested to perform the following actions before claiming MURIDEO product as defective:

- (a) Owner must notify MURIDEO, during the warranty period, in writing of alleged defect, and allow MURIDEO a reasonable opportunity to inspect the allegedly defective product;
- (b) No Product may be returned without MURIDEO's consent, The MURIDEO RMA# must accompany all returns, and all returns must be delivered to MURIDEO within the warranty period;
- (c) Owner may, then at its own expense, return the allegedly defective Product, freight pre-paid and in the original packaging, accompanied by a brief statement explaining the alleged defect to MURIDEO;
- (d) If MURIDEO determines that any returned Product is not defective, or if MURIDEO determines that the defect is not covered by the warranty, MURIDEO will return the Product to the Owner at Owner's expense, freight collect, and Owner agrees to pay MURIDEO's reasonable cost of handling and testing;
- (e) Upon determining that a returned product is defective, to receive warranty service Owner will need to present the invoice showing the original purchase transaction. If shipping the product, Owner will need to package it carefully and send it, transportation prepaid by a traceable, insured method, to the MURIDEO Service Center. Package the product using adequate padding material to prevent damage in transit. The original container is ideal for this purpose. Include the RMA #, your name, return shipping address, email address and telephone number where you may be reached during business hours, inside the shipping package with the unit. Any replacement unit will be warranted under these Terms and Conditions for the remainder of the original warranty period or ninety (90) days whichever is longer.

Refer to user manual available for download on our website <http://www.murideo.com/> for important tips on how to operate and troubleshoot the product.

Limitation of Liability

MURIDEO reserves the right to refuse warranty service of products under disputable conditions. MURIDEO also holds the rights to declare final decision whether products are within warranty conditions. The following actions and damages will result in voiding the limited warranty:

- Damage caused by act of nature, such as fire, flood, wind, earthquake, lightning, etc.
- Damage or incompatibility caused by failure to perform a proper installation or to provide an appropriate operational environment for the product, including but not limited to unstable wired/wireless network connection and phone lines, bad grounding, external electro-magnetic fields, direct sunlight, high humidity and vibration.
- Damage caused by impact with other objects, dropping, falls, spilled liquids, or submersion in liquids.
- Damage caused by unauthorized repair or disassembling of the product.
- Damage caused by any other abuse, misuse, mishandling, or misapplication.
- Damage caused by third party peripherals (including but not limited to visible damages on motherboard or other electronic parts of the product such as burn spots after electric discharge, melting, fusing, splitting, etc.)
- Any unauthorized software or modification of built-in software not approved by MURIDEO.
- The serial number of the product (or serial number stickers of its parts) has been modified, removed, blurred or damaged.
- Defects caused by transportation, handling or customer abuse.

Disclaimer of Warranty

THIS WARRANTY IS EXPRESSED IN LIEU OF ALL OTHER WARRANTIES, EXPRESSED OR IMPLIED, INCLUDING THE IMPLIED WARRANTY OF MERCHANTABILITY, THE IMPLIED WARRANTY OF FITNESS FOR A PARTICULAR PURPOSE AND OF ALL OTHER OBLIGATIONS OR LIABILITIES ON MURIDEO'S PART, AND IT NEITHER ASSUMES NOR AUTHORIZES ANY OTHER PARTY TO ASSUME FOR MURIDEO ANY OTHER LIABILITIES. THE FOREGOING CONSTITUTES THE BUYER'S SOLE AND EXCLUSIVE REMEDY FOR THE FURNISHING OF DEFECTIVE OR NONCONFORMING PRODUCTS AND MURIDEO WILL NOT IN ANY EVENT BE LIABLE FOR COST OF SUBSTITUTE OR REPLACEMENT, COST OF FACILITIES OR SERVICE, DOWNTIME COSTS, LOSS OF PROFITS, REVENUES OR GOODWILL, RELIANCE DAMAGES, LOSS OF DATA, LOSS OF USE IF OR DAMAGE TO ANY ASSOCIATED EQUIPMENT, OR ANY OTHER INDIRECT, INCIDENTAL, SPECIAL, OR CONSEQUENTIAL DAMAGES BY REASON OF THE FACT THAT SUCH PRODUCTS WILL HAVE BEEN DETERMINED TO BE DEFECTIVE OR NONCONFORMING. THE RIGHTS AND OBLIGATIONS OF THE PARTIES UNDER THIS AGREEMENT SHALL NOT BE GOVERNED BY THE PROVISIONS OF THE 1980 U.S. CONVENTION ON CONTRACTS FOR THE INTERNATIONAL SALE OF GOODS OR THE UNITED NATIONS CONVENTION ON THE LIMITATION PERIOD IN THE INTERNATIONAL SALE OF GOODS, AS AMENDED (COLLECTIVELY, THE "CONVENTIONS"); RATHER, THE RIGHTS AND OBLIGATIONS OF THE PARTIES SHALL BE GOVERNED BY THE LAWS OF THE STATE OF SOUTH DAKOTA, INCLUDING ITS PROVISIONS OF THE UNIFORM COMMERCIAL CODE, AS APPLICABLE. FOR THE AVOIDANCE OF DOUBT, THE CONVENTIONS ARE HEREBY EXCLUDED.

This Limited Warranty gives you specific legal rights. You may also have other rights that may vary from state to state or from country to country. You are advised to consult applicable state or country laws for full determination of your rights. Some jurisdictions do not allow the exclusion or limitation of special, incidental or consequential damages, or limitations on how long a warranty lasts, so the above exclusion and limitations may not apply to everyone.

Getting Help

For service and support, contact your local dealer.

To find your dealer or to contact MURIDEO support, go to: <https://support.murideo.com/>

Or call

+1-605-330-8491 for worldwide technical support

Legal Notices

MURIDEO® Logos are trademarks or registered trademarks of AVPro Global Holdings, Inc. in the United States or other countries. ISF® and the ISF logo are trademarks or registered trademarks of, and are used under license from, Imaging Science Foundation, LLC. in the United States or other countries.

All other trademarks and registered trademarks are the property of their respective owners in the United States or other countries. The absence of a trademark symbol does not constitute a waiver of Silicon Image's trademarks or other intellectual property rights with regard to a product name, logo or slogan.

The logo for DIREKTRONIK is displayed in a bold, italicized, red font with a white outline, set against a yellow background that curves upwards from the bottom of the page.

Direktronik AB tel. 08-52 400 700 www.direktronik.se